

Canon

Exif Print

**BUBBLE JET
DIRECT**

PictBridge

Office All-in-One

PIXMA MP530

User's Guide



ENG

QT5-0210-V02

Getting Help from Canon

Help Us Help You Better

Before you contact Canon, please record the following information.

Serial Number (located on the inside of the product): _____

Model Number (located on the front of the product): _____

Setup CD-ROM number (located on the CD-ROM): _____

Purchase Date: _____

Customer Technical Support Sequence*

1. Internet — www.canontechsupport.com

For quick and comprehensive self-help in an intuitively guided interactive troubleshooting environment, the place to start is our helpful tech support web site. In addition, the latest driver downloads, answers to frequently asked questions, product information, and “where to buy” instructions are found here.

2. Email Tech Support — www.canontechsupport.com

For individual attention to a special issue, try emailing our friendly technical support representatives, specially trained to communicate quick, easy, and logical solutions to your inquiries within 24 hours.

3. Toll-Free Live Tech Support — (1-800-828-4040)

This option provides live telephone technical support, free of service charges, Monday-Saturday (excluding holidays), during your product's 1 year limited warranty period. Telephone Device for the Deaf (TDD) support is available at (1-866-251-3752).

4. Extended Service and Support — www.canonesp.com

Canon CarePAK Extended Service Plan is a cost-attractive and easy-to-use extended service program that provides up to three full years of service and support coverage at a very attractive price. CarePAK offers toll-free Canon technical support and includes Canon's superb InstantExchange product replacement program. For further information about extending your Canon service and support, call (1-800-385-2155), or visit our Web site at www.canonesp.com. CarePAK must be purchased during your product's warranty period.

For more information and updated program specifics, please visit our web site at www.canontechsupport.com.

Table of Contents

Copyright	3	8 Routine Maintenance	98
Disclaimer	3	Replacing an Ink Tank	98
Model Name	4	Getting the Ink Level Information	98
Trademarks	4	Knowing When to Replace Ink Tank	99
How to Use the Documentation Provided	4	Replacing Ink Tanks	99
Safety Precautions	5	When Printing Becomes Faint or	
Reading the Document	10	Colors are Incorrect	103
Symbols Used in This Guide	10	Printing the Nozzle Check Pattern	104
Legal Limitations on Use of Your Product and		Print Head Cleaning	105
Use of Images	11	Print Head Deep Cleaning	106
1 Before Printing	12	Aligning the Print Head Automatically	106
Main Components and Their Functions	12	Cleaning Your Machine	107
Turning the Machine ON and OFF	18	9 Troubleshooting	111
Document Handling	19	If the Power Disconnects Unexpectedly	113
Loading Paper	22	An Error Message is Displayed on the	
Changing the Page Size and Media Type	37	LCD	113
2 Copying	40	Cannot See the Display on the LCD	113
Making Copies	40	Ink Does Not Come Out/Printing is Blurred/	
Changing the Copy Settings	41	Colors are Wrong/White Streaks/	
Using Useful Copy Functions	45	Straight Lines are Misaligned/	
3 Printing Photographs Directly from a		Cannot Print to End of Job	119
Compliant Device	53	Back of Paper is Smudged/Paper Does Not	
Connecting to a PictBridge Compliant		Feed Properly/Printed Surface is	
Device	53	Scratched	122
Printing Photographs Directly from a		Paper Jams	127
PictBridge Compliant Device	55	Document Jams	130
Printing Photographs Directly from a Canon		Cannot Print Properly from the Digital	
Bubble Jet Direct Compatible Digital		Camera	133
Camera	58	Cannot Install the MP Drivers	135
4 Faxing	60	Cannot Connect to Computer Properly	137
Preparing Your Machine for Fax	60	Problems Receiving Faxes	138
Sending Faxes	71	Problems Sending Faxes	140
Receiving Faxes	78	Telephone Problems	141
5 Printing from Your Computer	84	Problems Scanning	141
Windows		An Error Message Appears	
Printing with Windows	84	on the Screen	146
Macintosh		If You Cannot Resolve the Problem	149
Printing with Macintosh	86	10 Appendix	151
6 Scanning Images	89	Printing Area	151
About Scanning Images	89	How to Read the On-screen Manuals	153
Scanning Methods	89	Uninstalling the On-screen Manuals	153
7 Changing the Machine Settings	91	Transporting Machine	154
Changing the Settings	91	Specifications	155
PRINT SETTINGS	91	Users in the U.S.A.	160
FAX SETTINGS	92	Pre-Installation Requirements for MP530	160
OTHERS	96	Connection of the Equipment	160
RESTORE DEFAULT	96	In Case of Equipment Malfunction	161
SAVE CONFIG	97	Rights of the Telephone Company	161
LOAD CONFIG	97	FCC Notice	161
		Canon U.S.A., INC. LIMITED WARRANTY	
		--- (USA Only)	163
		Users in Canada	166
		Pre-Installation Requirements for Canon	
		Facsimile Equipment	166

Customer Technical Supports 167
Users in New Zealand 168
Index 169

Copyright

This manual is copyrighted by Canon Inc. with all rights reserved.

Under the copyright laws, this manual may not be reproduced in any form, in whole or in part, without the prior written consent of Canon Inc.

© 2006 Canon Inc.

Disclaimer

Canon Inc. has reviewed this manual thoroughly in order that it will be an easy-to-use guide to your Canon MP530 Series. All statements, technical information and recommendations in this manual and in any guides or related documents are believed reliable, but the accuracy and completeness thereof are not guaranteed or warranted, and they are not intended to be, nor should they be understood to be, representation or warranties concerning the products described.

Specifications are subject to change without notice.



As an ENERGY STAR® partner, Canon Inc., has determined that this product meets the ENERGY STAR guidelines for energy efficiency.

All information regarding non-Canon products was compiled from publicly available information. No representation is made regarding the accuracy thereof.



Super G3 is a phrase used to describe the new generation of fax machines that use ITU-T V.34 standard 33.6 Kbps* modems. Super G3 High Speed Fax machines allow transmission time of approximately 3 seconds* per page which results in reduced telephone line charges.

* Approximately 3 seconds per page fax transmission time based on ITU-T No. 1 Chart (Standard Mode) at 33.6 Kbps modem speed.

The Public Switched Telephone Network currently supports fax modem speeds of 28.8 Kbps or lower, depending on telephone line conditions. Sending and receiving fax machines need to conform to ITU-T V.34 guidelines.



This machine supports Exif 2.2 (also called "Exif Print").

Exif Print is a standard for enhancing the communication between digital cameras and printers.

By connecting to an Exif Print-compliant digital camera, the camera's image data at the time of shooting is used and optimized, yielding extremely high quality prints.

Model Name

K10269 (PIXMA MP530)

Trademarks

- "Windows" is a trademark of Microsoft Corporation, registered in the United States and other countries.
- "Macintosh" and "Mac" are trademarks of Apple Computer, Inc., registered in the U.S. and other countries.

How to Use the Documentation Provided

Easy Setup Instructions (Printed documentation)



Be sure to read this sheet first.

This sheet includes instructions for setting up your machine and getting it ready for use.

User's Guide (This guide)

Read this guide when starting to use the machine.

After following instructions in the *Easy Setup Instructions*, read this guide for instructions on printing from your computer, direct photo printing from selected digital cameras, copying, faxing, and scanning.

On-screen Manuals



Refer to these guides as needed for full instructions on some of the more advanced features.

Printer Driver Guide

Refer to this guide for full instructions on setting the printer driver.

Scan Guide

Refer to this guide for full instructions on scanning operation and settings.

FAX Driver Guide

Refer to this guide for full instructions on setting the fax driver.

Photo Application Guide

Refer to this guide for instructions on using various application software included on the Setup CD-ROM.

Safety Precautions

Please read the safety warnings and cautions provided in this guide to ensure that you use your machine safely. Do not attempt to use the machine in any way not described in this guide.

Warning

You may cause an electric shock/fire or damage the machine if you ignore any of these safety precautions.

Location	Do not place the machine close to flammable solvents such as alcohol or thinners. If flammable substances come into contact with electrical parts inside the machine, it may result in fire or electrical shock.
Power supply	Never attempt to plug or unplug the machine from the power supply when your hands are wet. This may result in electrical shock.
	Always push the plug all the way into the power outlet. If the prongs of the power plug come into contact with metal objects, it may result in fire or electrical shock.
	Never damage, modify, stretch or excessively bend or twist the power cord. Do not place heavy objects on the power cord. These actions may cause electrical damage and result in fire or electrical shock.
	Never plug the machine into a power socket that is shared with other equipment (extension lead/cord, 2- or 3-way adapter, etc.). This may result in fire or electrical shock.
	Plug the machine into a standard 110-240 V AC, 50/60 Hz (depending on your local electrical requirements), two-prong* grounded outlet. Operate the machine only from the type of power source indicated on the machine's label or a fire, electrical shock, or malfunction may occur. If you are unsure of the type of power available, consult your local power company. * The shape of the plug and outlet may vary depending on the country of purchase.
	Do not allow the power cord to be near objects that emit heat. The outer cover of the power cord may melt resulting in fire or electrical shock.
	Never use the machine if the power cord is bundled or knotted. Knots in the cord may result in fire or electrical shock.
	If you detect smoke, unusual smells or strange noises around the machine, immediately unplug the machine at the power supply and contact the Canon Customer Care Center. Using the machine in such conditions may result in fire or electrical shock.
Maintenance	Do not service the machine yourself except as specifically described in this guide. If further servicing is required, contact the Canon Customer Care Center.
	When storing the machine, choose a location where the machine is not exposed to dust. Dust accumulation may prevent the machine from operating properly.
	Use a damp cloth to clean the machine. Never use flammable solvents such as alcohol, benzene or thinners. If flammable solvents come in contact with electrical components inside the machine, it could cause a fire or electrical shock.
	Always turn OFF the power and unplug the machine from the power outlet before cleaning the machine. If you leave on or accidentally switch the machine ON while cleaning it, it may result in injury or damage the machine.

Handling	Do not attempt to disassemble or modify the machine. There are no user serviceable parts inside the machine. The machine contains high-voltage components. Never attempt any maintenance procedure not described in this guide. Incorrect maintenance procedures may damage the machine, or cause a fire or electrical shock.
	Do not drop paper clips, staples, or other metal objects inside the machine. Also do not spill water, liquid, or flammable substances inside the machine. If these items come into contact with high-voltage parts inside the machine, it may result in fire or electrical shock. If these items are dropped or spilled in the machine, turn OFF the power and unplug the power cord immediately with dry hands. Then contact the Canon Customer Care Center.
	Do not use flammable sprays near the machine. This could cause a fire or electrical shock if the spray comes into contact with electrical components inside the machine.
	There are high-voltage components inside the machine. If you are looking inside the machine to clear paper jams etc., do not allow metal objects such as jewelry to come into contact with the inside of the machine. Contact may result in burns or electrical shock.
	Others
This product emits low level magnetic flux. If you use a cardiac pacemaker and feel abnormalities, please move away from this product and consult your doctor.	
When setting the machine near electric products with fluorescent lighting, separate the machine at least 5.9 inches (15 cm) from electric products equipped with fluorescent lighting. If you place it near to them, the machine may malfunction as a result of the noise emitted by the fluorescent lighting.	
When turning OFF the power, be sure to press [ON/OFF] and confirm that the Alarm Lamp has shut off. If you pull the power plug out of the wall outlet while the Alarm Lamp is lit or flashing, the Print Head is not protected, and you may not be able to print later.	

⚠ Caution

You may cause injury or damage the machine if you ignore any of these safety precautions.

Location	Do not block or cover the ventilation port or any openings on the machine with objects, as it may cause the inside of machine to overheat and cause a fire.
	Place the machine on a flat, stable, vibration-free surface that is strong enough to support its weight. If the machine topples over, it may result in injury. (For the weight of the machine, see "Appendix" on page 151.)
	Do not use or store the machine outdoors.
	Do not install the machine near devices that contain magnets or generate magnetic fields, such as speakers.
	To ensure proper ventilation, make sure the machine is approximately 4 inches (10 cm) away from walls and other equipment.
	Do not install the machine in a location that is very humid or dusty, in direct sunlight, outdoors, or close to a heating source. Installing in such a location may result in fire or electrical shock.
	To avoid the risk of fire or electrical shocks, install the machine in a location with an ambient temperature range of 41°F to 95°F (5°C to 35°C) and humidity of 10% to 90% (condensation free).
	Do not place the machine on a thick rug or carpet. If fibers or dust come inside the machine, it could cause a fire.

Power supply	Never remove the plug by pulling on the cord. Pulling on the power cord may damage the cord and cause a fire or electrical shock.
	When turning OFF the power, be sure to press [ON/OFF] and unplug the machine. However, if the machine is unplugged during printing, the Print Head is not protected with the cap that prevents the ink from drying. This may affect the print quality of the machine when printing later.
	During electrical storms, turn OFF the power and disconnect the power cord from the power outlet.
	Do not use an extension cord as this may result in fire or electrical shock.
	Ensure that the area around the power outlet is kept clear at all times so you can easily unplug the power cord if necessary. Otherwise you will be unable to disconnect the power plug in case of an emergency, and it may result in fire or electrical shock.
	Never use a power supply source other than the one rated for the machine in the country where you purchased the machine as it may result in fire or electrical shock. The operating requirement of this machine is as follows: 110-240 V AC, 50/60 Hz (depending on local electrical requirements)
	Do not plug the machine into the same circuit as appliances such as an air conditioner, television, or copier. These devices generate electrical noise which may interfere with your machine's operation.
	Whenever you turn OFF the power and unplug the machine, wait at least one minute before you plug it in again.
	Use only the power cord that came with the machine. Using a different power cord may cause electric leakage or damage to the machine.
	Turn OFF the power and unplug the machine in the following conditions: <ul style="list-style-type: none"> ● When the power cord or plug is damaged or frayed. ● If liquid has spilled into the machine. ● If the machine has been exposed to rain or water. ● If the machine does not operate normally when you have followed the instructions in the guides included with your machine. ● If the machine does not operate normally when you have followed the instructions provided in "Troubleshooting" on page 111. ● If the machine has been dropped or damaged. ● If the machine exhibits a distinct change in performance, indicating a need for servicing.
	Turn OFF the power and disconnect the power cord if the machine will not be used for a long period such as during holidays.
	The socket-outlet shall be installed near the equipment and shall be easily accessible.

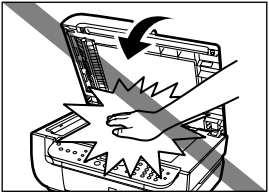
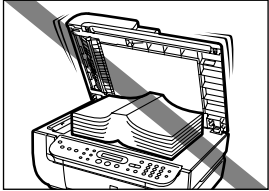
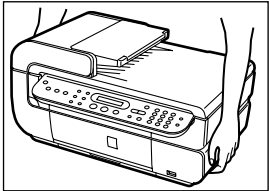
Handling	<p>Close the Document Cover gently to avoid catching your hand. Failing to do so may result in personal injury.</p>	
	<p>Do not press down hard on the Document Cover when using the Platen Glass to scan thick books. This may damage the Platen Glass and Document Cover and/or result in personal injury.</p>	
	<p>Do not place the following objects on top of the machine. If such objects come into contact with internal electrical components, the machine may short-circuit, resulting in fire or electrical shock.</p> <ul style="list-style-type: none"> ● Metal objects such as jewelry and watches ● Containers of water or other liquids such as glasses, vases, or pot plants <p>If water does spill inside the machine, turn OFF the power immediately by pressing the [ON/OFF], and disconnect the power cord. Then, contact the Canon Customer Care Center.</p>	
	<p>Do not touch the high-voltage electrical parts as this may result in electrical shock.</p>	
	<p>Do not place heavy objects on top of the machine as these may topple over and result in injury.</p>	
	<p>When removing paper jammed in the machine, be careful not to get ink on your hands or clothing. If ink gets on your hands or clothing, wash them soon in running water. If you use hot water, the ink may adhere and become difficult to remove.</p>	
	<p>After printing, do not touch the electrical contacts of the Print Head. They will be hot and may result in burns or electrical shock.</p>	
	<p>Do not subject the machine to strong physical shock or vibration. This can damage the machine's components.</p>	
	<p>Before moving the machine, turn OFF the power and unplug the machine.</p>	
	<p>When moving the machine, carry the machine at both ends.</p>	
	<p>A distinct change in performance may indicate a need for servicing.</p>	
	<p>Do not insert your hands into the machine while it is printing. Parts inside the machine are moving and this may result in injury.</p>	
	<p>Do not turn the machine upside down. Ink may leak out and stain clothing or the surrounding area.</p>	
	<p>Adjust only those controls that are covered by the instructions in the guides since improper adjustment of other controls may result in damage and require extensive repair by a qualified technician to restore the product to normal operation.</p>	
<p>When storing or transporting the machine, do not tilt it, stand it on its side, or turn it upside down. Doing so may cause ink to leak out.</p>		

Print Head/Ink tanks	For safety reasons, store print heads and ink tanks out of the reach of small children. If a child ingests any ink, consult a doctor immediately.
	Do not shake print heads or ink tanks. Ink may leak out and stain clothing or the surrounding area.
	Never touch the Print Head.

IMPORTANT SAFETY INSTRUCTIONS

When using your telephone equipment, basic safety precautions should always be followed to reduce the risk of fire, electric shock and injury to persons, including the following:

1. Do not use this product near water, for example, near a bath tub, wash bowl, kitchen sink or laundry tub, in a wet basement or near a swimming pool.
2. Avoid using this product during an electrical storm. There may be a remote risk of electric shock from lightning.
3. Do not use this product to report a gas leak in the vicinity of the leak.

SAVE THESE INSTRUCTIONS

Reading the Document

Symbols Used in This Guide

Please read the list below of symbols used in this guide. The following symbols are used to indicate important instructions. Be sure to obey these instructions.

Warning

Indicates a warning concerning operations that may lead to death or injury to persons if not performed correctly. In order to use the machine safely, always pay attention to these warnings.

Caution

Indicates a caution concerning operations that may lead to injury to persons or damage to property if not performed correctly. In order to use the machine safely, always pay attention to these cautions.

Important

Indicates operational warnings and restrictions. Be certain to read these items to operate the machine correctly and to avoid damage to the machine.

Note

Indicates notes for operation or additional explanations. Reading these is highly recommended.

Windows

Read this when the machine is connected to a Windows® system.

Macintosh

Read this when the machine is connected to a Macintosh® system.

Legal Limitations on Use of Your Product and Use of Images

It may be unlawful to make copies of, scan, print or use reproductions of the following documents. The list provided is non-exhaustive. When in doubt, check with a legal representative in your jurisdiction.

- Paper money
- Money orders
- Certificates of deposit
- Postage stamps (canceled or uncanceled)
- Identifying badges or insignias
- Selective service or draft papers
- Checks or drafts issued by governmental agencies
- Motor vehicle licenses and certificates of title
- Traveler's checks
- Food stamps
- Passports
- Immigration papers
- Internal revenue stamps (canceled or uncanceled)
- Bonds or other certificates of indebtedness
- Stock certificates
- Copyrighted works/works of art without permission of copyright owner

Chapter 1

Before Printing

Main Components and Their Functions

■ Front View

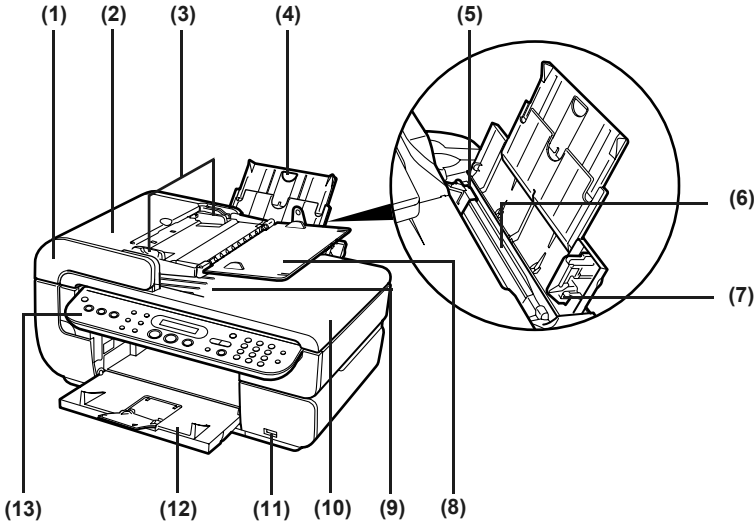

- (1) ADF (Auto Document Feeder)**
Automatically scans in documents loaded in the Document Tray.
- (2) Feeder Cover**
Open this cover when clearing jammed documents.
- (3) Document Guides**
Adjust these guides to match the document width.
- (4) Paper Support**
Supports paper loaded on the tray. Extend it before loading paper by putting your finger in the rounded hollow and pulling out the extension until it stops.
- (5) Paper Guide**
When loading paper, ensure that the left edge just touches this guide.
To move the Paper Guide, pinch the knob and slide in the appropriate direction.
- (6) Auto Sheet Feeder**
Load paper here before printing. Paper feeds automatically, one sheet at a time.
- (7) Cover Guide**
Align the right side of the paper to this guide.
- (8) Document Tray**
Open this tray to load a document. Once loaded, the document is fed one page at a time. Load the document with the side you want to scan face up.
- (9) Document Output Slot**
Documents scanned from the Document Tray are delivered here.
- (10) Document Cover**
Open this cover when loading a document on the Platen Glass.

(11) Direct Print Port

Connect the USB cable when printing directly from a digital camera or a digital video camcorder or a mobile phone equipped with a camera compatible with PictBridge or Canon Bubble Jet Direct. See "Printing Photographs Directly from a Compliant Device" on page 53.

(12) Paper Output Tray

Printouts are output to this tray. It opens automatically when copying or printing is started. If it is closed, press the Open Button.

(13) Operation Panel

Used to change the settings or operate the machine. See "Operation Panel Name and Functions" on page 16.

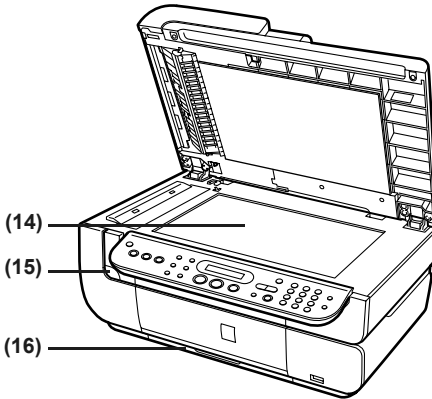

(14) Platen Glass

Used to load a document to be processed.

(15) Open Button

Press this button to open the Paper Output Tray.

(16) Cassette

Load paper to be used regularly here. Paper feeds automatically, one sheet at a time. Photo Stickers and 2.13" x 3.39" / 54.0 x 86.0 mm size paper are not loadable in the Cassette.

■ Rear View and Interior

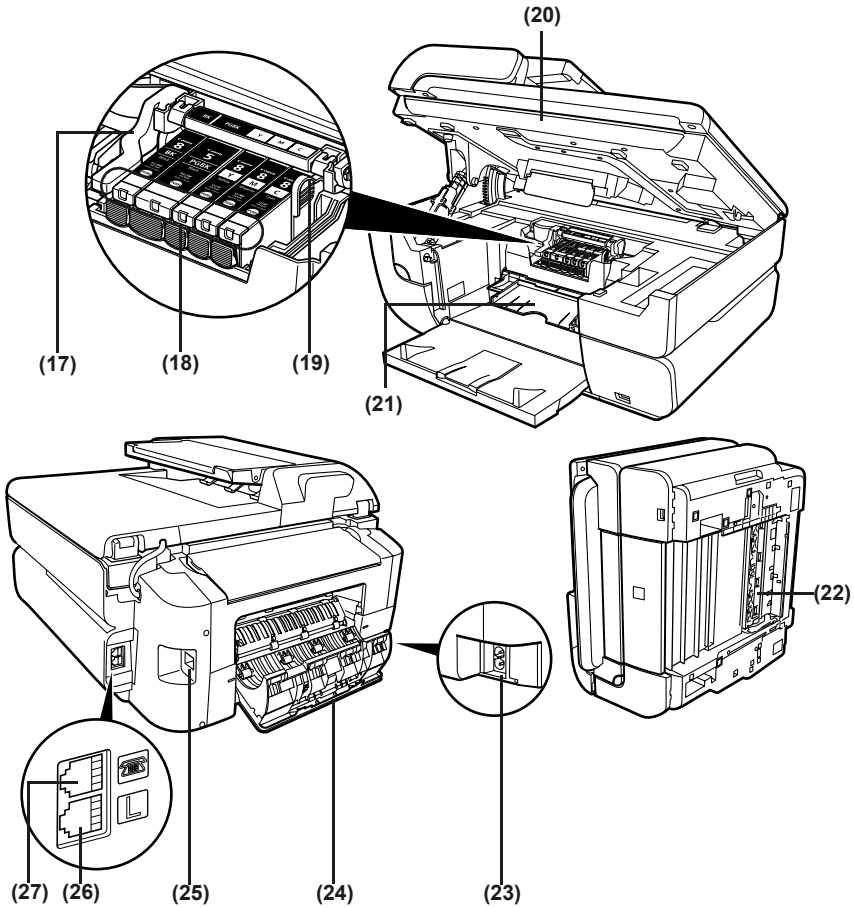

(17) Print Head Lock Lever

Used to fix the Print Head.

● Important

Do not pull up this lever after installing the Print Head.

(18) Ink Lamp

Lights or flashes red to indicate the status of the ink tank. You can check the status of each ink tank according to the way its lamp flashes. See “Ink Lamps” on page 15.

(19) Print Head Holder

Used to install a Print Head.

(20) Scanning Unit (Printer Cover)

This is the unit used to scan documents. Open this unit when replacing the ink tanks, or clearing jammed paper.

(21) Inner Cover

Open this cover when replacing the ink tanks, or clearing jammed paper.

(22) Duplexing Transport Unit

Open this unit when clearing jammed paper after pulling out the Cassette.

(23) Power Cord Connection

This is the connector used to connect the provided power cord.

(24) Rear Cover

Open this cover when clearing jammed paper.

(25) USB Port

This is the connector used to connect the machine to a computer using a USB cable.

 Important

While the machine is printing from or scanning images to the computer, or the computer is in the sleep mode or standby mode, do not disconnect and connect the USB cable.

(26) Telephone Line Jack

Connect the telephone line here.

(27) External Device Jack

Connect the external device here.

 Note

- For information on how to install the Print Head and ink tanks, refer to the *Easy Setup Instructions*.

Ink Lamps

- You can check the status of each ink tank according to the way its lamp flashes.

On: The machine is ready to print.

Slow flashing (about three seconds): Ink is low. Prepare a new ink tank. For details, see "Getting the Ink Level Information" on page 98.

Fast flashing (about one second): Ink tank is empty, or the machine is not ready due to an error.

Off: Make sure all the ink tanks are installed properly. If an ink lamp cannot light even after reinstalling ink tanks, an error has occurred and the machine is not ready to print.

■ Operation Panel Name and Functions

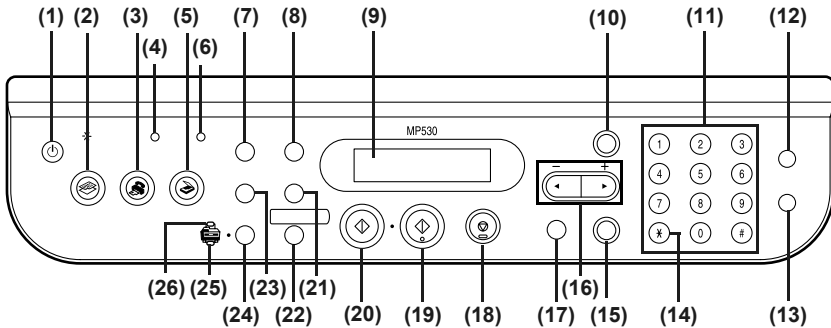

(1) [ON/OFF]

Turns the machine ON and OFF. Before turning ON the machine, make sure the Document Cover is closed.

Note

- The machine cannot receive faxes when the power is off.
- The power cannot be turned OFF while the machine is sending or receiving faxes, or when there are unsent faxes stored in the machine's memory.

(2) [COPY]

Switches the machine to the Copy mode. Flashes when the machine is turned on.

(3) [FAX]

Switches the machine to the Fax mode.

(4) In Use/Memory Lamp

Flashes when the telephone line is in use. Lights when there are documents stored in the machine's memory.

(5) [SCAN]

Switches the machine to the Scan mode. This button is used when the machine is connected to a computer (Refer to the *Scan Guide*).

(6) Alarm Lamp

Lights or flashes orange, when an error occurs, or when paper or ink has run out.

(7) [Exposure]

Sets the copy intensity and fax intensity.

(8) [Enlarge/Reduce]

Sets the reduction or enlargement ratio for copying.

(9) LCD (Liquid Crystal Display)

Displays messages, menu selections, and the operation status.

(10) [Menu]

Displays menus to configure copy, fax, or machine settings.

(11) Numeric Buttons

Enters numerical values such as the number of copies, as well as fax/telephone numbers and characters.

(12) [Redial/Pause]

Redials the last dialed number using numeric buttons. Also enters pauses between or after numbers when dialing or registering numbers.

(13) [Coded Dial]

Press this button and a two-digit code to dial a pre-registered fax/telephone number.

(14) [Tone]

Switches temporarily to tone dialing. Also changes the mode when entering characters.

(15) [OK]

Finalizes your selection for the menu or setting item.

Restores the machine to normal operation after a printing error was resolved, or if paper jams are cleared. Ejects documents remaining in the ADF.

(16) [(-) ◀] and [▶ (+)]

Scrolls through menu selections, and increases or decreases the number of copies. For the fax settings, [◀] cancels the entered character, and [▶] enters a space between characters.

(17) [Back]

Returns to the previous screen.

(18) [Stop/Reset]

Cancels operations. If this button is pressed during printing, the machine aborts printing. Resets the settings for the number of copies, for the ratio of reduction/enlargement, for the intensity, and on <1.SPECIAL COPY>.

Also enables you to return to the standby screen after you set some menus.

(19) [Color]

Starts color copying or faxing.

(20) [Black]

Starts black & white copying or faxing.

(21) [Paper]

Sets the page size and media type for copying, and for received faxes.

(22) [Two-Sided]

Selects two-sided copying.

(23) [Image Quality]

Sets the copy resolution and fax resolution.

(24) [Feed Switch]

Selects the paper source. Press this toggle switch to change the paper source between the Auto Sheet Feeder and Cassette.

(25) Cassette Lamp

Lights when the Cassette is selected.

(26) Auto Sheet Feeder Lamp

Lights when the Auto Sheet Feeder is selected.

Turning the Machine ON and OFF

Turn on the machine before starting printing.

■ Turning on the Machine

Before turning on the machine, confirm that the Print Head and ink tanks are set into place.

Note

If preparatory operations above are not yet finished, follow the *Easy Setup Instructions* to complete them.

- 1 To turn on the machine, press [ON/OFF].
[COPY] flashes green for a while, and then turns on.

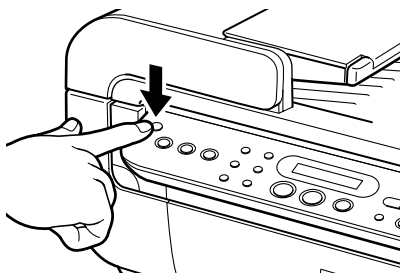

Note

- If the Alarm Lamp lights or flashes orange and an error message is displayed on the LCD, see “An Error Message is Displayed on the LCD” on page 113.
- The machine goes into the Power Saver Mode if not operated for the specified time (the default is 5 minutes) (See “Setting the Power Saver Mode” on page 18). Press any button to restore the display.

■ Turning off the Machine

- 1 To turn off the machine, press [ON/OFF].

The machine is off when the currently selected Mode button (e.g. [COPY]) stops flashing and all Operation Panel lamps are off.

Important

When removing the power plug after turning off the machine, be sure to check that all the lamps on the Operation Panel are not lit. If the power plug is removed from the wall outlet with the lamps on the Operation Panel lighting or flashing, the machine cannot protect its Print Head and may be unable to print.

Note

The power cannot be turned OFF while the machine is sending or receiving a fax, or when there are unsent faxes stored in the machine's memory.

■ Setting the Power Saver Mode

<POWER SAVER MODE> will be displayed on the screen, if the machine is not operated for the specified time (the default is 5 minutes).

You can change the interval of time to go into the Power Saver Mode as follows:

- 1 Press [Menu] repeatedly to select <DEVICE SETTINGS>.
- 2 Use [◀] or [▶] to select <OTHERS>, and press [OK].
- 3 Use [◀] or [▶] to select <PWR SAVE SETTING>.



- 4 Press [OK].
- 5 Use [◀] or [▶] to select the time to switch the machine to the Power Saver mode.
5 MINUTES / 15 MINUTES / 1 HOUR / 8 HOURS
- 6 Press [OK].
- 7 Press [Stop/Reset].

Document Handling

This section describes how to load the document on the Platen Glass or in the ADF.

■ Document Requirements

The documents you load on the Platen Glass or in the ADF for copying, faxing, or scanning must meet these requirements:

	Platen Glass	ADF
Document type	<ul style="list-style-type: none"> ● Special types of paper ● Photographs ● Book ● Documents that are not suitable for the ADF 	Multipage documents of the same size, thickness, and weight
Size (W x L)	Max. 8.5" x 11.7" / 216 x 297 mm	Max. 8.5" x 14.0" / 216 x 356 mm Min. 5.8" x 5.8" / 148 x 148 mm
Quantity	1 sheet	<ul style="list-style-type: none"> ● Max. 30 pages of A4- or letter-size sheets (20 lb / 75 gsm paper), up to 4 mm in height ● Max. 10 pages of legal-size sheets (20 lb / 75 gsm paper), up to 2 mm in height ● 1 sheet for sizes other than these
Thickness	Max. 0.39" / 10 mm	0.002" to 0.005" / 0.06 to 0.13 mm
Weight	—	13 to 24 lb / 50 to 90 gsm

■ Loading Documents

Load documents that you want to copy, fax, or scan on the Platen Glass or in the ADF.

Note

- Make sure any glue, ink, correction fluid, or the like is completely dry before loading the document.
- Remove all staples, paper clips, and the likes before loading the document.

● **Using the Platen Glass**

- 1 Open the Document Cover.
- 2 Load your document on the Platen Glass.
 - Place your document face down on the Platen Glass.
 - Align the upper left corner of your document with the alignment mark on the upper left corner of the Platen Glass.

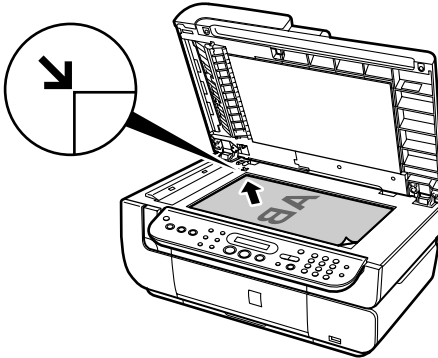

Note

- The machine cannot scan the area within about 0.08" / 2 mm from the rear edge, and within about 0.08" / 2 mm from the left edge of the Platen Glass.
- You can also scan in originals that are up to 0.39" / 10 mm thick, such as books. Set them on the Platen Glass in the same way as documents.

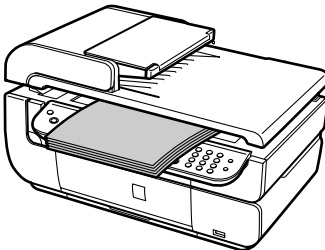

- 3 Gently close the Document Cover.

● Using the ADF

Note

- Set a document on the Platen Glass if you want to scan it at optimum quality.
- The area (range) within 0.08" / 2 mm from the top edge of document cannot be printed since the machine cannot scan it.
- Do not load the following types of documents in the ADF. They will jam.
 - Wrinkled or creased paper
 - Curled paper
 - Torn paper
 - Paper with holes
 - Carbon paper or carbon-backed paper
 - Surface treated paper
 - Onion skin or thin paper
 - Photograph or thick paper

- 1 Remove any documents from the Platen Glass.
- 2 Open the Document Tray.

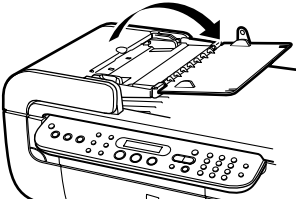

- 3 Load the document in the ADF (1).

Load the document with the side you want to copy, fax, or scan face up in the ADF.

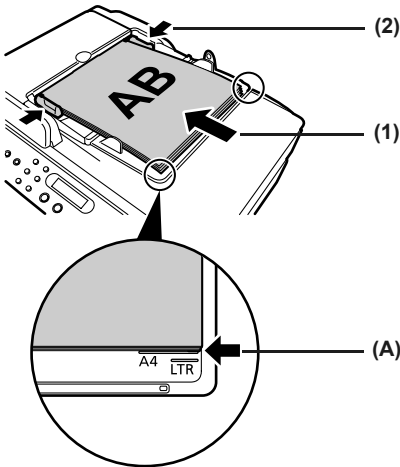

- 4 Adjust the Document Guides to match the document width (2).

Note

Ensure that the edge of the document stack is in line with the Paper Size Mark imprinted on the Document Tray (A).

Loading Paper

This section describes how to load paper in the Auto Sheet Feeder and Cassette.

■ Paper Handling

● Recommended Paper and Requirements

- Regarding the machine setting for media type when copying or printing without a computer, see the table in "Changing the Page Size and Media Type" on page 37.

Media Type	Model*1	Paper Support Load Limit		Printer Driver Setting for [Media Type]
		Auto Sheet Feeder	Cassette	
Plain Paper	—	0.51" / 13 mm	0.51" / 13 mm	[Plain Paper]
High Resolution Paper	HR-101N	80 sheets (A4, Letter)	80 sheets (A4, Letter)	[High Resolution Paper]
Super White Paper	SW-201	0.51" / 13 mm (A4, Letter)	0.51" / 13 mm (A4, Letter)	[Plain Paper]
Glossy Photo Paper	GP-401	10 sheets (A4, Letter), 20 sheets (4" x 6" / 101.6 x 152.4 mm, Credit Card)	10 sheets (A4, Letter), 20 sheets (4" x 6" / 101.6 x 152.4 mm), Not supported (Credit Card)*5	[Glossy Photo Paper]
Glossy Photo Paper "Everyday Use"	GP-501	10 sheets (A4), 20 sheets (4" x 6" / 101.6 x 152.4 mm)	10 sheets (A4), 20 sheets (4" x 6" / 101.6 x 152.4 mm)	[Glossy Photo Paper]
Matte Photo Paper	MP-101	10 sheets (A4, Letter), 20 sheets (4" x 6" / 101.6 x 152.4 mm)	10 sheets (A4, Letter), 20 sheets (4" x 6" / 101.6 x 152.4 mm)	[Matte Photo Paper]
Photo Paper Plus Double Sided*2, *3	PP-101D	10 sheets (A4, Letter, 5" x 7" / 127.0 x 177.8 mm)	10 sheets (A4, Letter, 5" x 7" / 127.0 x 177.8 mm)	[Photo Paper Plus Double Sided]
Photo Paper Plus Glossy*3	PP-101	10 sheets (A4, Letter, 5" x 7" / 127.0 x 177.8 mm), 20 sheets (4" x 6" / 101.6 x 152.4 mm)	10 sheets (A4, Letter, 5" x 7" / 127.0 x 177.8 mm), 20 sheets (4" x 6" / 101.6 x 152.4 mm)	[Photo Paper Plus Glossy]

Media Type	Model ^{*1}	Paper Support Load Limit		Printer Driver Setting for [Media Type]
		Auto Sheet Feeder	Cassette	
Photo Paper Plus Semi-gloss ^{*3}	SG-101	10 sheets (A4, Letter), 20 sheets (4" x 6" / 101.6 x 152.4 mm)	10 sheets (A4, Letter), 20 sheets (4" x 6" / 101.6 x 152.4 mm)	[Photo Paper Plus Glossy]
Photo Paper Pro ^{*3}	PR-101	10 sheets (A4, Letter), 20 sheets (4" x 6" / 101.6 x 152.4 mm)	10 sheets (A4, Letter), 20 sheets (4" x 6" / 101.6 x 152.4 mm)	[Photo Paper Pro]
Photo Stickers ^{*4}	PS-101	1 sheet	Not loadable ^{*5}	[Photo Paper Plus Glossy]
Transparencies	CF-102	30 sheets	30 sheets	[Transparencies]
T-Shirt Transfers ^{*2}	TR-301	1 sheet	1 sheet	[T-Shirt Transfers]
Envelopes ^{*2}	—	10 envelopes	5 envelopes	[Envelope]

Paper having a "Model Number" is Canon specialty media.

You may not be able to purchase some Canon branded paper depending on your country.

^{*1} Paper is not sold in the US by Model Number. Purchase paper by the name.

^{*2} This is available only when printing from your computer.

^{*3} When loading a stack of paper, the printed side may be marked when it is fed in. If this happens, load paper one sheet at a time.

^{*4} When Windows is being used, you can specify the print setting easily by using the Easy-Photo Print provided with the Setup CD-ROM.

^{*5} Feeding from the Cassette can damage the machine. Always load in the Auto Sheet Feeder.

Note

- For specifying the page size and media type when performing copy or print without a computer, see "Changing the Page Size and Media Type" on page 37.
- When using plain paper (17 lb / 64 gsm), up to 150 sheets (0.51" / 13 mm in height) can be loaded in the Auto Sheet Feeder and Cassette respectively. Select [Plain Paper] from [Media Type] in the printer driver.

For a detailed description of printing media types, refer to the *Printer Driver Guide*.

● Media Types You cannot Use

Do not use the following types of paper. Using such paper will not only produce unsatisfactory results, but can also cause the machine to jam or malfunction.

- Folded, curled or wrinkled paper
- Damp paper
- Excessively thin paper (less than 17 lb / 64 gsm)
- Excessively thick paper (more than 28 lb / 105 gsm)(non-Canon branded paper)
- Picture postcards
- Postcards affixed with photos or stickers
- Envelopes with double flaps
- Envelopes with sticker flaps

- Envelopes with an embossed or treated surface
- Any type of paper with holes

● Handling Paper

- Hold the paper as closely as possible to its edges and try not to touch the print surface. Print quality will deteriorate if the print surface is damaged or becomes dirty.
- Do not touch the print surface until the ink has dried. If prints get wet, do not touch the printed side until they dry.
- Paper may curl or the print surface may become smudged if you use a large amount of ink for printing. In this case, select <ON> for <PREVENT ABRASION> under <PRINT SETTINGS>. See “If printing surface abrasion is not resolved even after taking the actions above.” on page 126. Do not print photos or documents that contain graphics on paper that curls easily. Remove this kind of paper for printing text-only documents.
- If the paper is curled, uncurl it before printing. To uncurl the paper, see “Paper is curled.” on page 125.
- Put unused paper back into the package, and store them out of direct sunlight in a place where the temperature and humidity are low. Keep them on a level surface to avoid curling and wrinkling.
- If the printed area is traced with a highlight pen or paint-stick or stained with water or sweat, ink may blur depending on the paper.

● Photo Paper Pro Guidelines

- Do not touch the print surface until the ink is dry (approx. 30 minutes). Colors in dark images may appear indistinct at first, but will become clearer after approx. 30 minutes.
- Images may become smudged if you place them in an album before the ink is completely dry. It is recommended that you allow the ink to dry for 24 hours.
- Do not attempt to dry the ink with a hair dryer or by exposing printouts to direct sunlight.
- Do not store or display printouts in hot, damp, or humid conditions. Never expose them to heat or direct sunlight.
- Store printouts in photo albums, photo frames, or presentation binders to protect them from direct exposure to air or sunlight.
- Do not mount printouts in an adhesive-type album as you may not be able to remove them.
- Be aware that some types of clear plastic folders and albums may cause the edges of the paper to turn yellow.

■ About the Auto Sheet Feeder and Cassette

You can load paper in both the Auto Sheet Feeder and Cassette.

Loading paper in the Auto Sheet Feeder is easy, and is convenient if you frequently switch to and print on various sizes or types of paper.

Loading paper in the Cassette allows you to print without reloading paper for each job. This is convenient for loading a certain type of paper, such as plain paper, you regularly print onto.

Loading paper in both the Auto Sheet Feeder and Cassette makes the following paper feed methods available:

Some types of paper cannot be used on the Cassette. See “Recommended Paper and Requirements” on page 22.

● Changing the Paper Source to Feed Different Types/Sizes of Paper

If you load plain paper in the Cassette and photo paper in the Auto Sheet Feeder, changing the paper source allows you to print on both types of paper without removing and reloading paper. To change the paper source, use [Feed Switch] on the machine or printer driver.

You can also specify the type/size of paper to be fed from the Cassette for regular use with the printer driver. For example, you can specify that Letter-sized plain paper is always fed from the Cassette whenever you print.

Note

- For information on page size, media type, and paper support load limit for Auto Sheet Feeder or Cassette, see “Recommended Paper and Requirements” on page 22.
- For information on the printer driver settings, refer to the *Printer Driver Guide*.

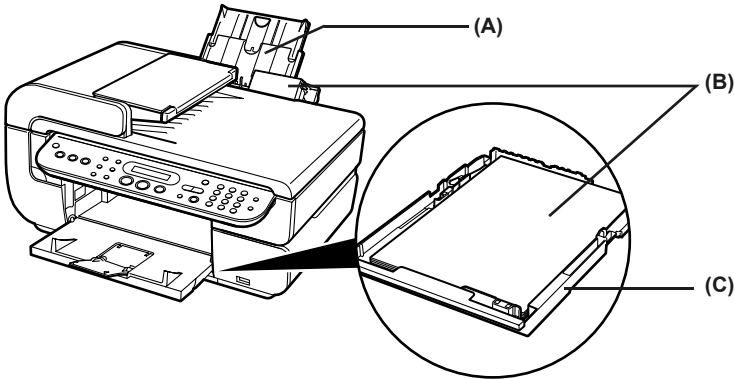

(A) Auto Sheet Feeder

(B) You can switch between paper loaded in the Auto Sheet Feeder (e.g., 4" x 6" / 101.6 x 152.4 mm) or Cassette (e.g., A4/Letter-sized paper).

(C) Cassette

● Continuous Printing on the Same Type/Size of Paper by Using Both the Auto Sheet Feeder and Cassette together

If the Auto Sheet Feeder or Cassette runs out of paper, the paper source automatically switches to the other one. This is useful for printing onto a large volume of paper.

Important

- When printing from a computer, you need to set this feature with the printer driver. For details, refer to the *Printer Driver Guide*.
- This feature can be used only when paper of the same size and media type are loaded in the Cassette and Auto Sheet Feeder.
- When printing from a computer, this feature can be used only when both paper sources are loaded with paper other than Credit Card- or Legal-sized paper.
- In Copy mode, this feature can be used only when both paper sources are loaded with paper other than Credit Card- or Legal-sized paper.
- In Fax mode, this feature can be used only when both paper sources are loaded with A4- or Letter-sized plain paper.
- This feature cannot be used for the Sticker copy.

Note

For information on page size, media type, and paper support load limit for the Auto Sheet Feeder or Cassette, see "Recommended Paper and Requirements" on page 22.

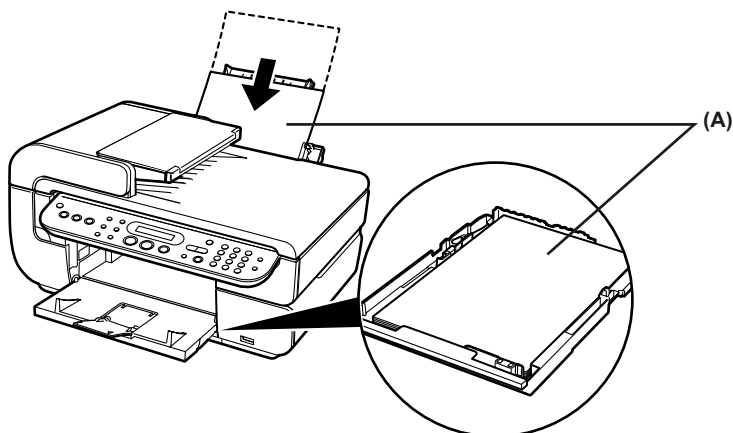

(A) If the Auto Sheet Feeder runs out of paper, the paper source automatically changes to the Cassette.

Procedure:

- 1 Press [Menu] repeatedly to select <DEVICE SETTINGS>.
- 2 Use [◀] or [▶] to select <PRINT SETTINGS>, and press [OK].
- 3 Use [◀] or [▶] to select <AUTO FEED SWITCH>.

```
PRINT SETTINGS
◀ AUTO FEED SWITCH
```

- 4 Press [OK].
- 5 Use [◀] or [▶] to select whether to switch the paper source automatically.

```
AUTO FEED SWITCH
◀ *OFF
```

ON: Switches the paper source automatically.

OFF: Switches the paper source by pressing [Feed Switch] on the Operation Panel.

- 6 Press [OK].
- 7 Press [Stop/Reset].

■ Changing the Paper Source

Before printing, confirm that the location where you have loaded paper is selected as a paper source. Press [Feed Switch] to change the paper source.

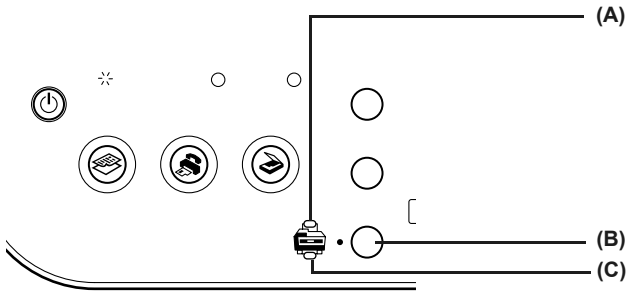

(A) Auto Sheet Feeder Lamp

(B) [Feed Switch]

(C) Cassette Lamp

Note

- Press [Feed Switch] so that the Auto Sheet Feeder Lamp lights when loading paper in the Auto Sheet Feeder and the Cassette Lamp lights when loading paper in the Cassette.
- You can also select the paper source with the printer driver when printing from the computer. For details, refer to the *Printer Driver Guide*.

■ Loading the Print Media in the Auto Sheet Feeder

Important

Load plain paper (A4-, letter-, or legal-size) when receiving faxes.

● Loading Paper

Note

For detailed information on the specialty media Canon provides for use with its various printers, see “Recommended Paper and Requirements” on page 22.

- 1 Flatten the four corners of the paper before loading it.

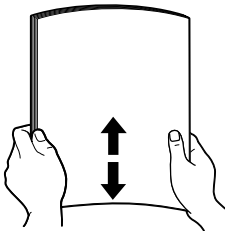

Note

- Align the edges of paper neatly before loading. Loading paper without aligning the edges may cause paper jams.
- When paper is curled, hold the opposing curled corners and gently bend them in the opposite direction until the paper becomes completely flat. See “Paper is curled.” on page 125.

- 2 Prepare to load paper.

- (1) Open the Paper Support, then pull out the Paper Support Extension to support the paper.
- (2) Press the Open Button to open the Paper Output Tray.
- (3) Open up and set the Paper Output Tray Extension completely by pressing down the hollow on its front side.
- (4) Press [Feed Switch] so that the Auto Sheet Feeder Lamp (A) lights.

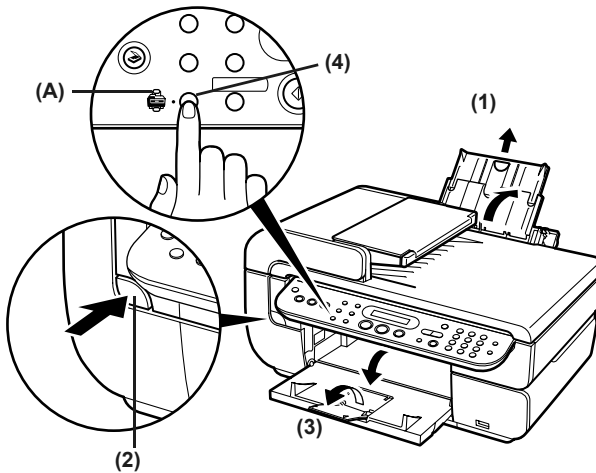

Note

You can also select the paper source with the printer driver. For details, refer to the *Printer Driver Guide*.

3 Load the paper.

- (1) Load the paper into the Auto Sheet Feeder with the print side face up.
- (2) Align the paper stack to the Cover Guide on the right side of the Paper Support.

Important

Ensure that the Cover Guide stands when you load paper in the Auto Sheet Feeder.

- (3) Pinch the Paper Guide and slide it against the left side of the paper stack.

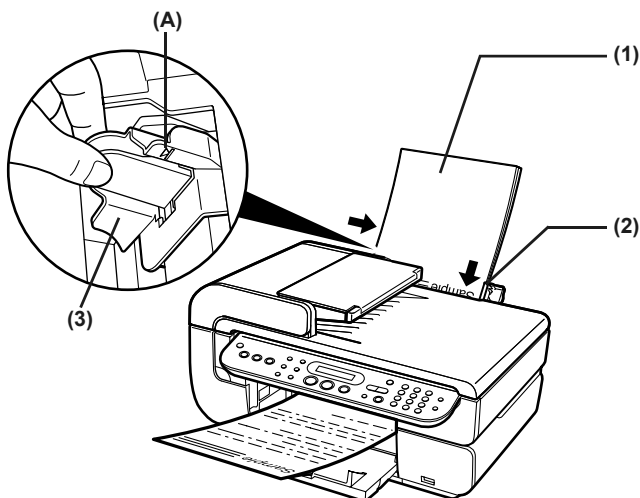

Important

Do not load the paper beyond this Load Limit Mark (A).

Note

- You can use general copy paper or Canon's Super White Paper SW-201.
- You can load up to 150 sheets of plain paper (17 lb / 64 gsm, 0.51" / 13 mm in height) in the Auto Sheet Feeder. However, the paper may not be fed normally depending on its media type or your environment where the temperature and humidity are high or low. In that case, reduce the amount of paper to half (approx. 0.2" / 5 mm in height).
- Remove the printed sheets from the Paper Output Tray before the count reaches 50.
- Do not touch the printed surfaces until the ink dries. For specific drying times, refer to the instructions packaged with your media.

● Loading Envelopes

Use either European DL or US Comm. Env. #10 size envelopes.

Important

- Envelopes can be used only when printing from a computer.
- Do not use envelopes with embossed or treated surfaces, a double flap, pressure seals or sticker flaps.
- Select either [DL Env.] or [Comm. Env. #10] according to the envelope size you are using.
- If the print image is upside down when printing onto special envelopes, open the printer properties dialog box then select the [Rotate 180 degrees] check box on the [Page Setup] tab.

For information on the printer driver settings, refer to the *Printer Driver Guide*.

- 1 Load the envelope against the Cover Guide on the right side of the Paper Support with the front face up, and the rear flaps down on the left.

Important

Ensure that the Cover Guide stands when you load paper in the Auto Sheet Feeder.

Note

A maximum of 10 envelopes can be loaded at once.

- 2 Pinch the Paper Guide and slide it against the left side of the envelope.
- 3 Press [Feed Switch] so that the Auto Sheet Feeder Lamp lights.
- 4 Select [Envelope] in [Media Type], and then select [DL Env.] or [Comm. Env. #10] in [Page Size].

For information on the printer driver settings, refer to the *Printer Driver Guide*.

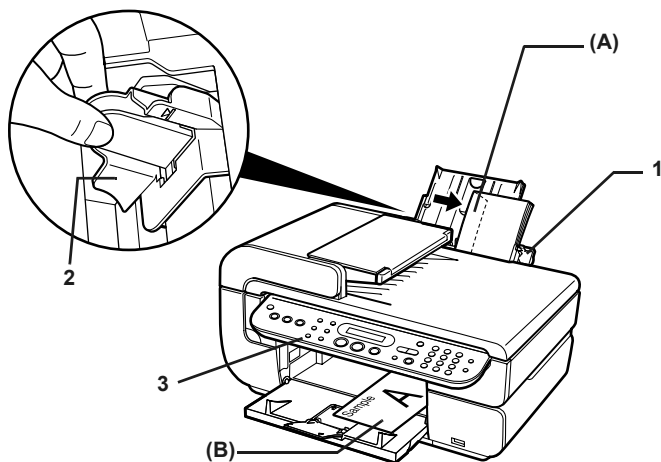

Note

- Fold the envelope flap shut (A).
- Printing direction (B).

● Loading Other Small-Sized Paper in the Auto Sheet Feeder

Important

Cutting plain paper to 4" x 6" / 101.6 x 152.4 mm, 5" x 7" / 127.0 x 177.8 mm, or 2.13" x 3.39" / 54.0 x 86.0 mm (Credit Card) size for a trial printing can cause paper jams.

- 1 Load the paper into the Auto Sheet Feeder with the print side face up and align the Cover Guide on the right side of the Paper Support.

Important

Ensure that the Cover Guide stands when you load paper in the Auto Sheet Feeder.

Note

- Load the paper lengthways regardless of the direction of the document.
- You can load up to 20 sheets of 4" x 6", or Credit Card-sized paper, and 10 sheets of 5" x 7"-sized paper.

- 2 Pinch the Paper Guide and slide it against the left side of the paper stack.

- 3 Press [Feed Switch] so that the Auto Sheet Feeder Lamp lights.
- 4 When performing copy or print without a computer, press [Paper] to select the page size. When using the machine connected to a computer, select the page size of the loaded paper from [Page Size] in the printer driver.

For a detailed description of the printer driver settings, see “Printing with Windows” on page 84, or “Printing with Macintosh” on page 86.

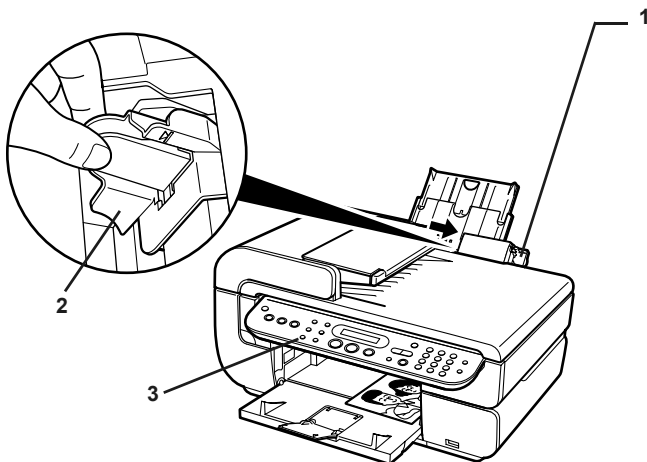

Important

Always load paper in portrait orientation (A). Loading paper in landscape orientation (B) can cause the paper to be jammed.

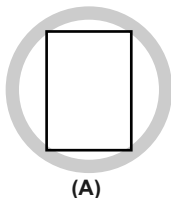

(A)

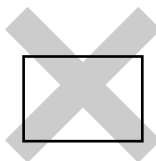

(B)

Note

We recommend using genuine Canon photo media when printing photographs. See “Recommended Paper and Requirements” on page 22.

■ Loading the Print Media in the Cassette

Depending on page size and media type, some paper must always be loaded in the Auto Sheet Feeder.

If you intend to use only the Cassette, check any usage restrictions in advance.

See “Recommended Paper and Requirements” on page 22.

● Loading Paper

● Important

Load plain paper (A4- or letter-size) when receiving faxes.

📖 Note

- Load legal-size paper in the Auto Sheet Feeder since it cannot be loaded into the Cassette.
- For detailed information on the specialty media Canon provides for use with its various printers, refer to “Recommended Paper and Requirements” on page 22.

- 1 Flatten the four corners of the paper before loading it.

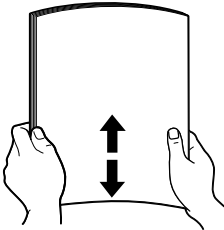

📖 Note

- Align the edges of paper neatly before loading. Loading paper without aligning the edges may cause paper jams.
- When paper is curled, hold the opposing curled corners and gently bend them in the opposite direction until the paper becomes completely flat. See “Paper is curled.” on page 125.

- 2 Prepare to load paper.

- (1) Pull out the Cassette from the machine.

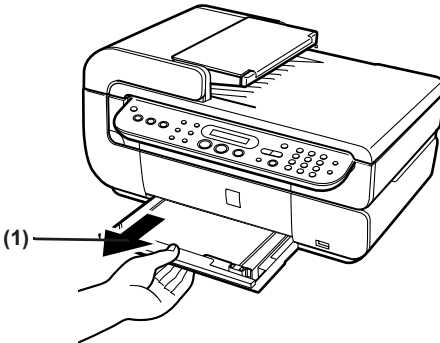

- 3 Load the paper (Print side face down).

- (1) Load the paper into the Cassette with the print side face down.
- (2) Align the paper stack to the right side of the Cassette.
- (3) Slide the Paper Guides to fit the loaded paper stack.

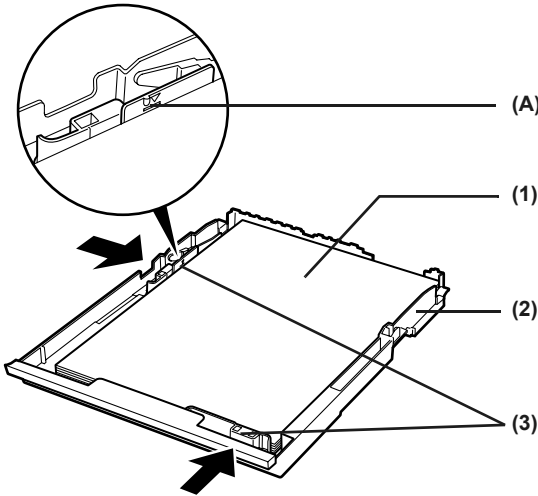

Important

Do not load the paper beyond this Load Limit Mark (A).

Note

- You can use general copy paper or Canon's Super White Paper SW-201.
- You can load up to 150 sheets of plain paper (17 lb / 64 gsm, 0.51" / 13 mm in height) in the Cassette. However, do not stack more than 50 sheets in the Paper Output Tray.
- Do not touch the printed surfaces until the ink dries. For specific drying times, refer to the instructions packaged with your media.

4 Insert the Cassette into the machine.

- (1) Insert the Cassette into the machine.
Push the Cassette all the way into the machine.

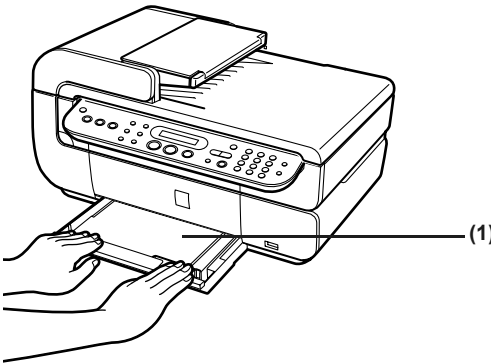

5 Prepare the Paper Output Tray.

- (1) Press the Open Button to open the Paper Output Tray.

- (2) Open up and set the Paper Output Tray Extension completely by pressing down the hollow on its front side.
- (3) Press [Feed Switch] so that the Cassette Lamp (A) lights.

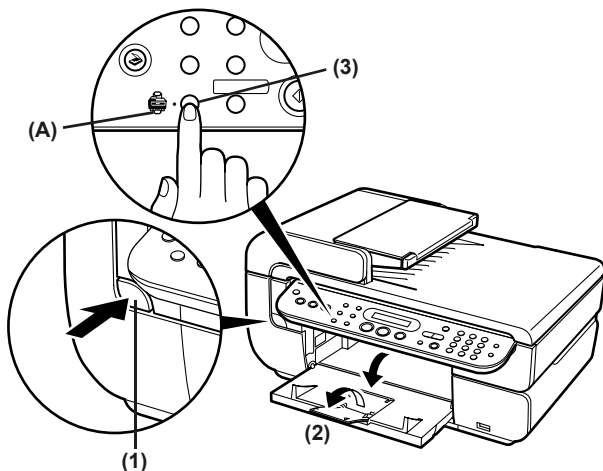

Note

You can also select the paper source with the printer driver. For details, refer to the *Printer Driver Guide*.

● Loading Envelopes

Use either European DL or US Comm. Env. #10 size envelopes.

Important

- Envelopes can be used only when printing from a computer.
- Do not use envelopes with embossed or treated surfaces, a double flap, pressure seals or sticker flaps.
- Select either [DL Env.] or [Comm. Env. #10] according to the envelope size you are using.
- If the print image is upside down when printing onto special envelopes, open the printer properties dialog box then select the [Rotate 180 degrees] check box on the [Page Setup] tab.

For information on the printer driver settings, refer to the *Printer Driver Guide*.

- 1 Align the envelope stack against the right side of the Cassette with the print side face down, and the rear flaps up on the left side.

Note

A maximum of 5 envelopes can be loaded at once.

- 2 Slide the Paper Guides against the sides of the envelope.

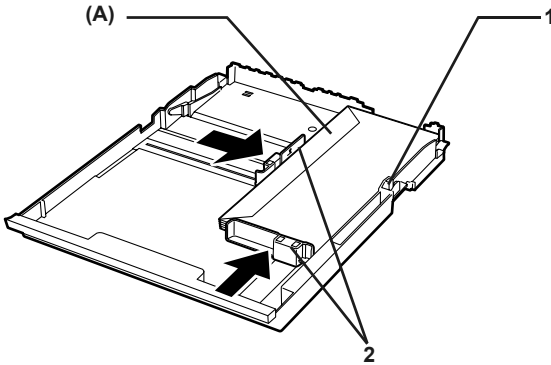

Note

Fold the envelope flap shut (A).

- 3 Press [Feed Switch] so that the Cassette Lamp lights.

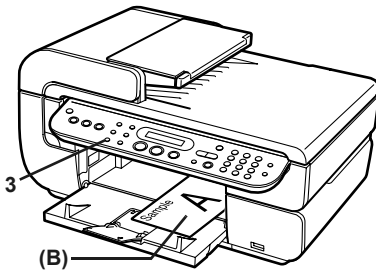

Note

Printing direction (B).

- 4 Select [Envelope] in [Media Type], and then select [DL Env.] or [Comm. Env. #10] in [Page Size].

For information on the printer driver settings, refer to the *Printer Driver Guide*.

● **Loading 4" x 6"- or 5" x 7"-Sized Paper in the Cassette**

Important

- Do not leave photo paper, such as Photo Paper Pro, in the Cassette for a long time. This may cause paper discoloration due to natural aging.
- If you are using photo paper such as Photo Paper Pro and have loaded them in the Cassette, the printout may have roller traces on the print surface. To avoid this, load paper in the Auto Sheet Feeder.
- Cutting plain paper to 4" x 6" / 101.6 x 152.4 mm or 5" x 7" / 127.0 x 177.8 mm size for a trial printing can cause paper jams.

- 1 Load the paper into the Cassette with the print side face down.

Note

- Load the paper lengthways regardless of the direction of the document.
- You can load up to 20 sheets of 4" x 6"-sized paper or up to 10 sheets of 5" x 7"-sized paper.

2 Align the paper stack against the right side of the Cassette.

3 Slide the Paper Guides to fit the loaded paper stack.

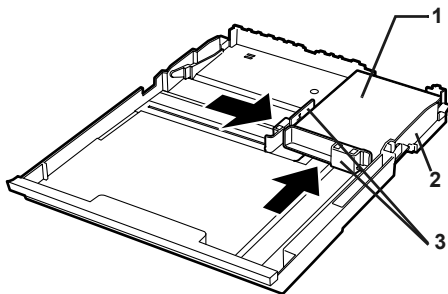

4 Press [Feed Switch] so that the Cassette Lamp lights.

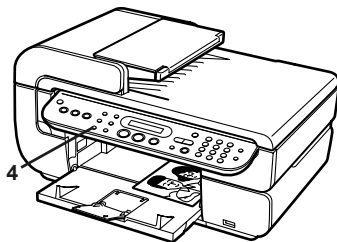

5 When performing copy or print without a computer, press [Paper] to select the page size. When using the machine connected to a computer, select the page size of the loaded paper from [Page Size] in the printer driver.

For a detailed description of the printer driver settings, see "Printing with Windows" on page 84, or "Printing with Macintosh" on page 86.

Important

Always load paper in portrait orientation (A). Loading paper in landscape orientation (B) can cause the paper to be jammed.

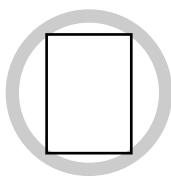

(A)

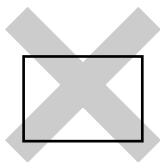

(B)

Note

We recommend using genuine Canon photo media when printing photographs.
See “Recommended Paper and Requirements” on page 22.

Changing the Page Size and Media Type

This section describes how to change the page size and media type on the Operation Panel.

Note

The asterisk <*> on the LCD indicates the current setting.

1 Press [Paper].

When you do not need to change the page size, press [OK] to proceed to step 4.

SIZE :	<	*A4	>
TYPE :		*PLAIN	

2 Use [◀] or [▶] to select the page size.

A4 / B5 / A5 / 4x6 / 5x7 / C-CARD / 8.5x11 / 8.5x14

Note

Some of these are not available depending on the country of purchase.

3 Press [OK].

SIZE :		*A4	
TYPE :	<	*PLAIN	>

4 Use [◀] or [▶] to select the media type.

PLAIN / PHOTO PRO / PHOTO PLUS / MATT PHOTO / GLOSSY

Note

In order to obtain optimal quality print results, when copying photographs, use Canon-recommended Photo Paper Pro or Photo Paper Plus Glossy.

For details on media, see “Recommended Paper and Requirements” on page 22.

5 Press [OK].

Note

The following table shows the limit number of paper to load into the Auto Sheet Feeder and Cassette.

● Recommended Paper and Requirements

Media Type	Model ^{*1}	Paper Support Load Limit		Machine Settings	
		Auto Sheet Feeder	Cassette	<SIZE>	<TYPE>
Plain Paper	—	0.51" / 13 mm	0.51" / 13 mm	<A4>/<8.5x11> (LTR)	<PLAIN>

Media Type	Model ¹	Paper Support Load Limit		Machine Settings	
		Auto Sheet Feeder	Cassette	<SIZE>	<TYPE>
Glossy Photo Paper	GP-401	10 sheets (A4, Letter)	10 sheets (A4, Letter)	<A4>/<8.5x11> (LTR)	<GLOSSY>
		20 sheets (4" x 6" / 101.6 x 152.4 mm)	20 sheets (4" x 6" / 101.6 x 152.4 mm)	<4x6> (101.6x152.4)	
		20 sheets (Credit Card)	Not supported (Credit Card) ⁴	<C-CARD>	
Glossy Photo Paper "Everyday Use"	GP-501	10 sheets (A4)	10 sheets (A4)	<A4>	<GLOSSY>
		20 sheets (4" x 6" / 101.6 x 152.4 mm)	20 sheets (4" x 6" / 101.6 x 152.4 mm)	<4x6> (101.6x152.4)	
Matte Photo Paper	MP-101	10 sheets (A4, Letter)	10 sheets (A4, Letter)	<A4>/<8.5x11> (LTR)	<MATT PHOTO>
		20 sheets (4" x 6" / 101.6 x 152.4 mm)	20 sheets (4" x 6" / 101.6 x 152.4 mm)	<4x6> (101.6x152.4)	
Photo Paper Plus Glossy ²	PP-101	10 sheets (A4, Letter, 5" x 7" / 127.0 x 177.8 mm)	10 sheets (A4, Letter, 5" x 7" / 127.0 x 177.8 mm)	<A4>/<8.5x11> (LTR)/<5x7> (127.0x177.8)	<PHOTO PLUS>
		20 sheets (4" x 6" / 101.6 x 152.4 mm)	20 sheets (4" x 6" / 101.6 x 152.4 mm)	<4x6> (101.6x152.4)	
Photo Paper Plus Semi-gloss ²	SG-101	10 sheets (A4, Letter)	10 sheets (A4, Letter)	<A4>/<8.5x11> (LTR)	<PHOTO PLUS>
		20 sheets (4" x 6" / 101.6 x 152.4 mm)	20 sheets (4" x 6" / 101.6 x 152.4 mm)	<4x6> (101.6x152.4)	
Photo Paper Pro ²	PR-101	10 sheets (A4, Letter)	10 sheets (A4, Letter)	<A4>/<8.5x11> (LTR)	<PHOTO PRO>
		20 sheets (4" x 6" / 101.6 x 152.4 mm)	20 sheets (4" x 6" / 101.6 x 152.4 mm)	<4x6> (101.6x152.4)	
Photo Stickers ³	PS-101	1 sheet	Not loadable ⁴	—	—

Paper having a "Model Number" is Canon specialty media.

You may not be able to purchase some Canon branded paper depending on your country.

¹ Paper is not sold in the US by Model Number. Purchase paper by the name.

² When loading a stack of paper, the printed side may be marked when it is fed in. If this happens, load paper one sheet at a time.

³ When printing photos on Photo Stickers, select <STICKER COPY> under <1.SPECIAL COPY>, then select <4 x 4> for <STKR TYP>. See "Creating Stickers (Sticker copy)" on page 47.

⁴ Feeding from the Cassette can damage the machine. Always load in the Auto Sheet Feeder.

 **Note**

- Regarding the printer driver setting for media type, see “Recommended Paper and Requirements” on page 22.
- When using plain paper (17 lb / 64 gsm), up to 150 sheets (0.51" / 13 mm in height) can be loaded in the Auto Sheet Feeder and Cassette respectively.

Chapter 2

Copying

Making Copies

This section describes the basic procedure to make copies.

1 Prepare for copying.

- (1) Press [ON/OFF] to turn on the machine.
See "Turning on the Machine" on page 18.
- (2) Press [COPY].
- (3) Load paper.
See "Loading Paper" on page 22.
- (4) Ensure that the proper paper source is selected.
See "Changing the Paper Source" on page 26.

Note

Press [Feed Switch] so that the Auto Sheet Feeder Lamp lights when loading paper in the Auto Sheet Feeder and the Cassette Lamp lights when loading paper in the Cassette.

- (5) Load the document on the Platen Glass or in the ADF.

Note

For information on the types and conditions of documents which you can copy, see "Loading Documents" on page 19.

2 Start copying.

- (1) Check the page size and media type.

Note

Press [Paper] to change the page size, or media type. See "Changing the Page Size and Media Type" on page 37.

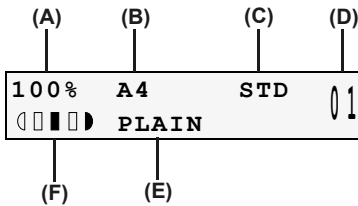

- (A) Ratio of Reduction/Enlargement
- (B) Page Size
- (C) Print Quality
- (D) Number of Copies
- (E) Media Type
- (F) Intensity

- (2) Use [◀] or [▶] to specify the number of copies.

Note

For information on the types and conditions of documents which you can copy, see "Loading Documents" on page 19.

- (3) Press [Color] for color copying, or [Black] for black & white copying.
The machine starts copying.

Note

- To cancel copying, press [Stop/Reset].
- The machine can also receive faxes in copy mode (when [COPY] is pressed).

Changing the Copy Settings

You can change the copy settings such as the reduction/enlargement, intensity, or image quality. For details on changing the page size and media type, see "Changing the Page Size and Media Type" on page 37.

■ Reducing or Enlarging a Copy

You can reduce or enlarge copies using three different methods:

Preset copy ratios: You can select one of the preset ratios to reduce or enlarge copies.

Custom copy ratios You can specify the copy ratio as a percentage to reduce or enlarge (Zoom): copies.

Automatic ratios The machine automatically reduces or enlarges the image to fit the page (Fit to Page): size.

The following sections describe how to use these methods.

● Using Preset Copy Ratios

Preset copy ratios are convenient when changing between standard page sizes, for example, reducing A4 to A5 size, or enlarging 4" x 6" to letter size.

- 1 Press [Enlarge/Reduce].
- 2 Use [◀] or [▶] to select <PRESET RATIO>, then press [OK].

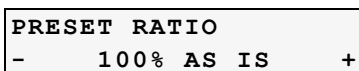

- 3 Use [◀] or [▶] to select the preset ratio.
25% / 70% / 86% / 100% / 115% / 141% / 400%
 - Pressing [◀] decreases the copy ratio and pressing [▶] increases the ratio.
 - Press and hold down [◀] or [▶] to quickly advance through the ratios.
- 4 Press [OK].

● Using Custom Copy Ratios (Zoom)

In addition to making reduction and enlargement decisions using preset copy ratios, you can use customized 1% decrement/increment.

- 1 Press [Enlarge/Reduce].

- 2 Use [◀] or [▶] to select <ZOOM>, then press [OK].

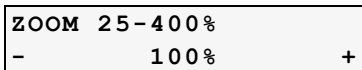

- 3 Use [◀] or [▶] to select a copy ratio by the percent between 25% and 400%.
 - Pressing [◀] decreases the copy ratio and pressing [▶] increases the ratio.
 - Press and hold down [◀] or [▶] to quickly advance through the ratios.

Note

The ratio can be also input by using the numeric buttons.

- 4 Press [OK].

● Using Automatic Copy Ratios (Fit To Page)

You can set the machine to automatically reduce or enlarge the document to fit the page size you selected in <SIZE>.

- 1 Press [Enlarge/Reduce].
- 2 Use [◀] or [▶] to select <FIT-TO-PAGE>.

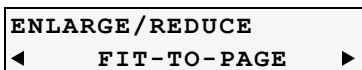

Note

When <FIT-TO-PAGE> is selected, the document loaded in the ADF cannot be scanned.

- 3 Press [OK].

The message <AUTO> appears on the LCD.

Note

If the document is not properly reduced or enlarged to fit the page size, use preset or custom copy ratios and try copying again.

■ Adjusting Exposure (Intensity)

Exposure (intensity) is the degree of difference between light and dark. Increasing the exposure setting further blackens dark areas and whitens bright areas. Conversely, decreasing the exposure setting reduces the difference between bright and dark areas. You can adjust the exposure between five gradations.

- 1 Press [Exposure].



- 2 Use [◀] or [▶] to select the <MANUAL ADJUST> or <AUTO ADJUST (A)>.
- 3 Press [OK].

- If you select <MANUAL ADJUST> in step 2, use [◀] to decrease the density, or use [▶] to increase the density, then press [OK].
- If you select <AUTO ADJUST (A)> in step 2, the screen below appears on the LCD.

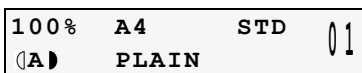

Note

When <AUTO ADJUST (A)> is selected, the document loaded in the ADF cannot be scanned.

■ Adjusting Image Quality

You can adjust the image quality according to the document to be copied.

- 1 Press [Image Quality].



- 2 Use [◀] or [▶] to select the image quality.

STANDARD: Suitable for text-only documents.

HIGH: Suitable for photographs.

FAST: Suitable for high speed copying at a lower image quality.

- 3 Press [OK].

Note

- When using <FAST>, if the quality is not as good as expected, select <STANDARD> or <HIGH> and try copying again.
- Select <HIGH> to copy in grayscale. Grayscale renders tones in a range of grays instead of black or white.

■ Copying onto Both Sides of the Paper (Two-sided copy)

You can copy two document pages onto the sides of a single sheet of paper.

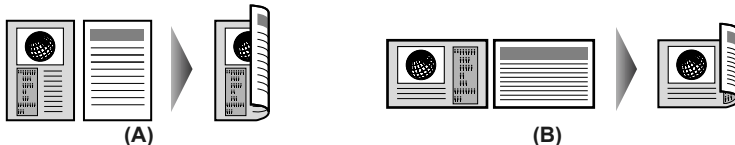

(A) Long-side stapling

(B) Short-side stapling

Procedure:

- 1 Press [Two-Sided] to select <STAPLE SIDE>.
- 2 Use [◀] or [▶] to select <LONG-SIDE STAPLE> or <SHORT-SIDE STAPLE>.

LONG-SIDE STAPLE: Staples on the long side of the paper.

SHORT-SIDE STAPLE: Staples on the short side of the paper.

3 Press [OK].

4 Press [Color] for color copying, or [Black] for black & white copying.

● **When the document was loaded on the Platen Glass:**

When the first sheet of document finishes to be scanned, the message below is displayed.

SCAN NEXT	→	[START]
START PRINT	→	[OK]

If you have another sheet of document to scan, load it on the Platen Glass and press [Start].

If you do not need more scanning, press [OK].

 **Note**

When you copy the second sheet of document, press the same [Start] button ([Black] or [Color]) as the first operation after loading the second sheet on the Platen Glass.

● **When the document was loaded in the ADF:**

The machine starts scanning the next sheet of document automatically after one sheet of document is scanned in.

 **Note**

- The ADF is not available for scanning two-sided documents at a stretch.
- This function cannot be used in conjunction with <FIT-TO-PAGE> under <ENLARGE/REDUCE> or other copy functions.
- If you perform black & white copying for two-sided copy, print intensity may be different from when performing black & white copying for single-sided copy.
- This function can only be used when the page size is set to <8.5 x 11> (215 x 279) or <A4>.
- The media type is fixed to <PLAIN>. You cannot change this setting.

Using Useful Copy Functions

■ Special Copy

You can copy in various layouts.

- 1 Prepare for copying.
See "Prepare for copying." on page 40.
- 2 Select the copy menu.

- (1) Press [Menu].
The SPECIAL COPY screen is displayed.

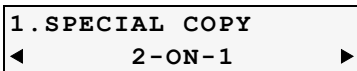

- (2) Use [◀] or [▶] to select the copy function.

- 2-ON-1: See "Copying Two Pages to Fit onto a Single Page (2-on-1 copy)" on page 45.
- 4-ON-1: See "Copying Four Pages to Fit onto a Single Page (4-on-1 copy)" on page 46.
- STICKER COPY: See "Creating Stickers (Sticker copy)" on page 47.
- BORDERLESS COPY: See "Copying without Borders (Borderless copy)" on page 48.
- IMAGE REPEAT: See "Repeating an Image on a Page (Image repeat)" on page 49.
- COLLATED COPY: See "Making Multiple Copies of an Entire Document (Collated copy)" on page 51.

■ Copying Two Pages to Fit onto a Single Page (2-on-1 copy)

This feature enables you to copy two documents (A) and (B) onto a single sheet (C) of paper by reducing each image.

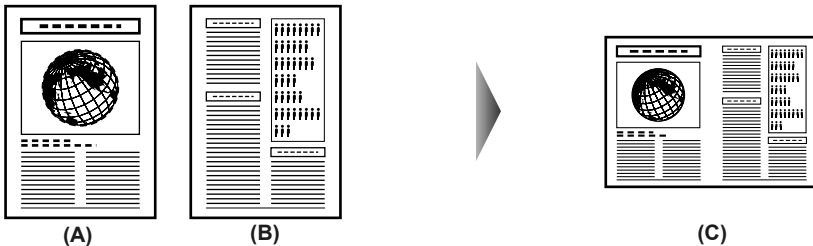

Note

- This function cannot be used in conjunction with other functions.
- If <MEMORY IS FULL> appears on the LCD when scanning, set the image quality to <STANDARD> or <FAST> and try copying again.
- You can use this feature only when the page size is set to <8.5 x 11> (215 x 279) or <A4>.

Procedure:

- 1 Display the Special copy screen.
See "Special Copy" on page 45.

- 2 Use [◀] or [▶] to select <2-ON-1>, then press [OK].
- 3 Load the document on the Platen Glass or in the ADF.
- 4 Specify the page size and media type.
See “Changing the Page Size and Media Type” on page 37.
- 5 Specify the necessary items.
See “Changing the Copy Settings” on page 41.

Note

You cannot select <ENLARGE/REDUCE>.

- 6 Press [Color] for color copying, or [Black] for black & white copying.

● **When the document was loaded on the Platen Glass:**

When the first sheet of document finishes to be scanned, the message below is displayed.

SCAN NEXT	→ [START]
START PRINT	→ [OK]

If you have another sheet of document to scan, load it on the Platen Glass and press [Start].

If you do not need more scanning, press [OK].

Note

When you copy the second sheet of document, press the same [Start] button ([Black] or [Color]) as the first operation after loading the second sheet on the Platen Glass.

● **When the document was loaded in the ADF:**

The machine starts scanning in the next sheet of document automatically after one sheet of document is scanned in.

■ **Copying Four Pages to Fit onto a Single Page (4-on-1 copy)**

This feature enables you to copy four documents onto a single sheet of paper by reducing each image. Four different layouts are available.

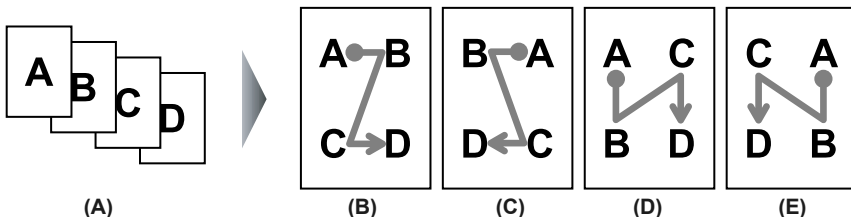

- (A) Documents
- (B) PATTERN 1
- (C) PATTERN 2
- (D) PATTERN 3
- (E) PATTERN 4

Procedure:

- 1 Display the Special copy screen.
See "Special Copy" on page 45.
- 2 Load the document on the Platen Glass or in the ADF.
- 3 Use [◀] or [▶] to select <4-ON-1>, then press [OK].



- 4 Use [◀] or [▶] to specify the layout pattern.
PATTERN 1 / PATTERN 2 / PATTERN 3 / PATTERN 4
- 5 Specify the page size and media type.
See "Changing the Page Size and Media Type" on page 37.
- 6 Specify the necessary items.
See "Changing the Copy Settings" on page 41.

 **Note**

You cannot specify <ENLARGE/REDUCE> for this function.

- 7 Press [Color] for color copying, or [Black] for black & white copying.

● **When the document was loaded on the Platen Glass:**

When the first to third sheet of document finishes to be scanned, the message below is displayed.

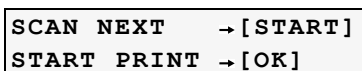

If you have another sheet of document to scan, load it on the Platen Glass and press [Start].

If you do not need more scanning, press [OK].

 **Note**

When you copy more than one sheet of document, press the same [Start] button ([Black] or [Color]) as the first operation after loading each sheet on the Platen Glass.

● **When the document was loaded in the ADF:**

The machine starts scanning in the next sheet of document automatically after one sheet of document is scanned in.

 **Note**

- This function cannot be used in conjunction with other copy functions.
- If <MEMORY IS FULL> appears on the LCD when scanning, set the image quality to <STANDARD> or <FAST> and try copying again.
- This function can be used only when page size is set to <8.5 x 11> (215 x 279) or <A4>.

■ **Creating Stickers (Sticker copy)**

You can easily make stickers from 4" x 6" / 101.6 x 152.4 mm photos or graphics using Canon Photo Stickers.

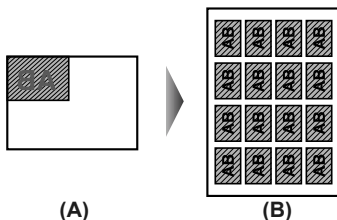

- (A) Platen Glass (Place document face down)
 (B) 16 stickers

Note

This function cannot be used in conjunction with other copy functions.

Procedure:

- 1** Display the Special copy screen.
See “Special Copy” on page 45.
- 2** Load the document on the Platen Glass.

Note

The document loaded in the ADF cannot be scanned.

- 3** Use [◀] or [▶] to select <STICKER COPY>, then press [OK].
- 4** Use [◀] or [▶] to select <4 x 4>.
You can only print in the 4 x 4 layout though other layouts appear on the LCD.
Use the special sheets of stickers.
- 5** Press [OK].
- 6** Specify the necessary items.
See “Changing the Copy Settings” on page 41.

Note

- You cannot specify the page size, media type, <ENLARGE/REDUCE> or <AUTO ADJUST (A)> as the intensity when using this function.
- The image quality is fixed to <HIGH>. Change the setting of the image quality as necessary after creating stickers.

- 7** Press [Color] for color copying, or [Black] for black & white copying.

Note

- Load stickers in the Auto Sheet Feeder when using this function.
- You can only load one sheet of stickers at a time in the Auto Sheet Feeder when using this function.

■ Copying without Borders (Borderless copy)

This feature enables you to copy color images so that they fill the entire page without borders.



Procedure:

- 1** Display the Special copy screen.
See “Special Copy” on page 45.
 - 2** Load the document on the Platen Glass.
- Note**
The document loaded in the ADF cannot be scanned.
- 3** Use [◀] or [▶] to select <BORDERLESS COPY>, then press [OK].
 - 4** Use [◀] or [▶] to select the page size.
A4 / 4 x 6 / 5 x 7 / C-CARD / 8.5 x 11
 - 5** Press [OK].
 - 6** Use [◀] or [▶] to select the media type.
PHOTO PLUS / MATT PHOTO / GLOSSY / PHOTO PRO
 - 7** Press [OK].
 - 8** Specify the necessary items.
See “Changing the Copy Settings” on page 41.
 - 9** Press [Color] for color copying, or [Black] for black & white copying.

Note

- The copied image may need to be enlarged to fit onto the selected page size when making borderless copies. Some cropping may occur.
- You can use this feature only when the page size is set to <A4>, <4 x 6> (101 x 152), <5 x 7> (127 x 177), <C-CARD>, or <8.5 x 11> (215 x 279).
- You can use this feature only when the paper is set to <PHOTO PLUS>, <MATT PHOTO>, <GLOSSY>, or <PHOTO PRO>.
- You can specify image quality to either <STANDARD> or <HIGH>.
- You can select the width to be cropped from the borders of the original image according to the image size.

■ **Repeating an Image on a Page (Image repeat)**

This feature enables you to copy an image multiple times onto a single page. You can set the machine to automatically select the number of times it repeats the image, or you can specify the number.

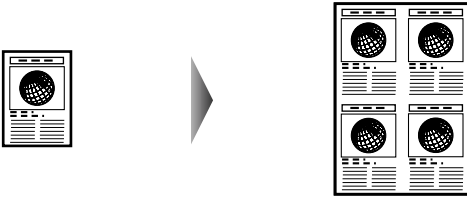

Procedure:

- 1 Display the Special copy screen.
See “Special Copy” on page 45.
- 2 Load the document on the Platen Glass or in the ADF.
- 3 Use [◀] or [▶] to select <IMAGE REPEAT>, then press [OK].
- 4 Use [◀] or [▶] to select <AUTO> or <MANUAL>.
If you selected <AUTO> and pressed [OK], go to step 8.
If you selected <MANUAL> and pressed [OK], go to step 5.

Note

When <AUTO> is selected, the document loaded in the ADF cannot be scanned.

- 5 Use [◀] or [▶] to set the vertical repeats (1 to 4).

VERTICAL	< 2 >
HORIZONTAL	2

- 6 Press [OK].
- 7 Use [◀] or [▶] to set the horizontal repeats (1 to 4).

VERTICAL	2
HORIZONTAL	< 2 >

- 8 Press [OK].
- 9 Specify the page size and media type.
See “Changing the Page Size and Media Type” on page 37.

Note

<C-CARD> cannot be selected for the page size.

- 10 Specify the necessary items.
See “Changing the Copy Settings” on page 41.

Note

<FIT-TO-PAGE> cannot be selected as the copy ratio.

11 Press [Color] for color copying, or [Black] for black & white copying.

Important

- The area read from the documents depends on the reduction/enlargement ratio.
- The size of the documents to copy should be no larger than one division of the paper. For example, if you copy four documents at the same size, their sizes must be one-fourth of the page size or smaller.

■ Making Multiple Copies of an Entire Document (Collated copy)

When making multiple copies of a document with more than one page you have them delivered in sorted sets.

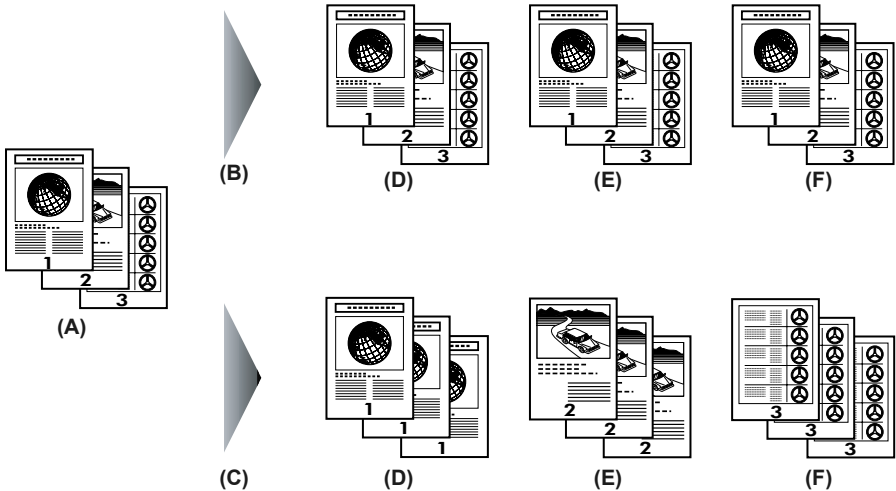

(A) Documents

(B) Select [COLLATED COPY]

(C) Not select [COLLATED COPY]

(D) Copy 1

(E) Copy 2

(F) Copy 3

Note

- This function cannot be used in conjunction with other special copyings.
- Load the document in the ADF when using this function.
- Using this function might cause a reduction in print quality. For best results, print without using collation.
- The number of sheets you can load depends on the document type.
- If <MEMORY IS FULL> is displayed when scanning, reduce the number of sheets and load them again.

Procedure:

1 Display the Special Copy screen.

See “Special Copy” on page 45.

2 Load the document in the ADF.

- 3 Use [◀] or [▶] to select <COLLATED COPY>, then press [OK].
- 4 Specify the page size and media type.
See “Changing the Page Size and Media Type” on page 37.
- 5 Specify the necessary items.
See “Changing the Copy Settings” on page 41.

 **Note**

You cannot select <FIT-TO-PAGE> as the copy ratio and <AUTO ADJUST (A)> as the intensity.

- 6 Press [Color] for color copying, or [Black] for black & white copying.

Chapter 3

Printing Photographs Directly from a Compliant Device

Connecting a PictBridge compliant device such as a digital camera, camcorder or mobile phone to the machine allows you to print recorded images directly without using a computer.

Note

- PictBridge is an industry standard enabling a range of digital photo solutions, including the direct printing of photos from a digital still camera, camcorder or mobile phone* without the need to use a computer.
- It is possible to specify which images to print and various print settings from the operation panel of your camera or mobile phone.
- Canon Bubble Jet Direct allows you to print photos from a Canon Bubble Jet Direct compatible (PictBridge incompatible) digital camera or digital video camcorder without a computer, by simply connecting the digital camera or digital video camcorder to this machine. For details, see “Printing Photographs Directly from a Canon Bubble Jet Direct Compatible Digital Camera” on page 58.

* Hereafter, the digital still camera, digital camcorder, and camera-equipped mobile phone compatible with PictBridge are collectively called a PictBridge compliant device.

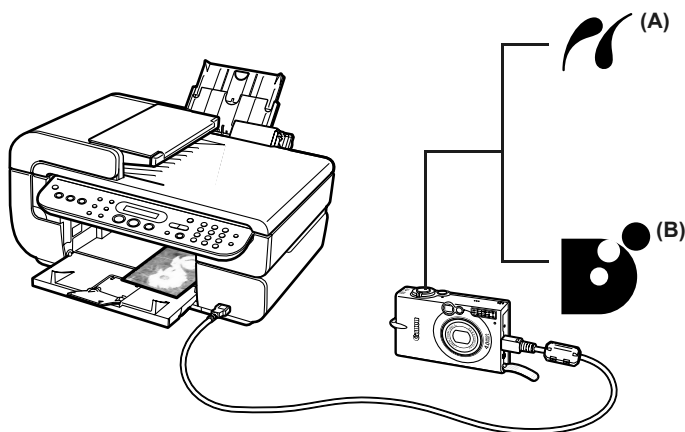

(A) This mark indicates that the product is PictBridge-compatible. See “Printing Photographs Directly from a PictBridge Compliant Device” on page 55.

(B) See “Printing Photographs Directly from a Canon Bubble Jet Direct Compatible Digital Camera” on page 58.

Connecting to a PictBridge Compliant Device

To connect a PictBridge compliant device to this machine, use the USB cable supplied with the device.

Caution

Do not connect any equipment other than PictBridge compliant devices or Canon Bubble Jet Direct compatible digital cameras to the Direct Print Port of the machine. If you do so, electric shock, fire, or damage to the device could result.

Important

Do not connect PictBridge compliant devices or Canon Bubble Jet Direct compatible digital cameras to the machine while copying, scanning, faxing or printing is in progress.

Note

When printing photos with the digital device connected to the machine, it is advisable to use the AC adapter supplied with the device. If you use the device battery, be sure to charge it fully.

1 Set up the machine.

Refer to the *Easy Setup Instructions* to set up the machine and make it ready for printing.

Note

The Print Head cannot be aligned using the controls of the digital device. If the Print Head alignment is not yet performed, execute automatic Print Head alignment, see “Aligning the Print Head Automatically” on page 106.

2 Turn on the machine.

See “Turning on the Machine” on page 18.

3 Load the paper in the machine.

See “Loading Paper” on page 22.

4 Connect the PictBridge compliant device to the machine.

Note

Depending on the model or brand of your device, you may have to select a print mode compliant with PictBridge before connecting the device.

You may also have to turn on the device or select Play mode manually after connecting the device to the machine.

Perform necessary operations according to the instruction manual supplied with the PictBridge compliant device.

(1) Ensure that the device is turned off.

(2) Connect the device to the machine using the USB cable (for connection to a computer) supplied with the device.

Note

Some types of the PictBridge compliant devices turn on automatically, when connected to the machine. If the device not turns on automatically, turn it on manually.

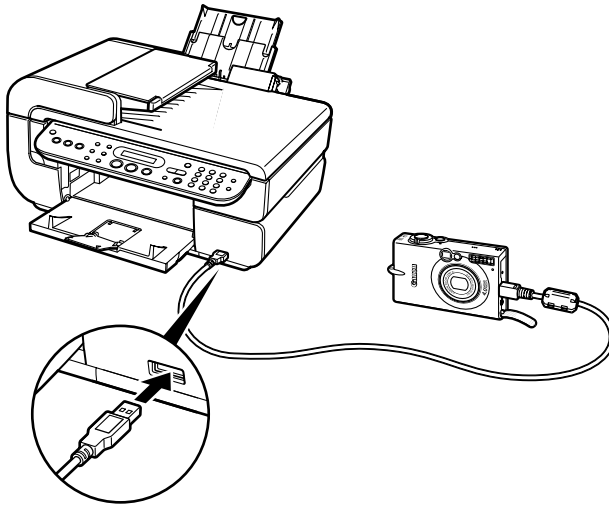

- (3) Turn on and set up the device for direct printing.
 Either of the following icons will display on the LCD display of the device when the machine is correctly connected.

 A PictBridge compliant device.

 A Canon Bubble Jet Direct compatible digital camera.

 **Note**

If neither of these icons appear, see “Cannot Print Properly from the Digital Camera” on page 133.

Printing Photographs Directly from a PictBridge Compliant Device

When operating the device, be sure to follow the instructions given in the instruction manual supplied with the PictBridge compliant device. Let’s take a look at the page size, media type, layout, image optimization modes, and date/file no. printing mode that can be set on a PictBridge compliant device connected to the machine.

■ Confirming or Changing the Device Settings

To change the page size or media type, operate the device to select the PictBridge print setup mode and confirm or change the settings.

The settings below can be changed by pressing <DEVICE SETTINGS> in [Menu] on this machine when a PictBridge compliant device is connected. However, changes can be made on the PictBridge setting screen only when the corresponding items below are in the “Default” (selections based on the machine setting) using the controls of the device.

PictBridge compliant device setting items	PictBridge setting items (PICTBRIDGE SET) on the machine
Paper size: Default	PAGE SIZE

PictBridge compliant device setting items	PictBridge setting items (PICTBRIDGE SET) on the machine
Paper type: Default	MEDIA TYPE
Layout: Default	BORDERLESS PRINT
Image Optimize: Default	IMAGE ENHANCEMENT

You can select the page size, media type, borderless printing, and optimize on the printer when printing from a PictBridge compliant device.

- (1) Turn on the machine.
- (2) Press [Menu] to select <DEVICE SETTINGS>, then press [OK].
- (3) Use [◀] and [▶] to select <PICTBRIDGE SET>, then press [OK].
- (4) Use [◀] and [▶] to specify the necessary items, then press [OK].

■ About the Settings Explained Below

The settings explained on the following pages cannot be made on some PictBridge compliant devices. If any setting cannot be made, the default setting explained above is used.

* Names of settings that are displayed on Canon PictBridge compliant device are used in the description given below. Different names may be displayed on your device depending on the brand or model.

■ About Image Data Format for Printing

This machine accepts images* taken with a camera compatible with the Design rule for Camera File System and PNG files.

* Exif 2.21 compliant

■ About “Paper size” and “Paper type”

When the “Default” (selections based on the machine setting) is selected, the machine operates based on the <SIZE> and the <TYPE> settings made using the controls of the machine.

The following sizes and types of paper can be loaded in the machine by selecting options from “Paper size” and “Paper type”.

“Paper size” setting	“Paper type” setting	Paper loaded in machine
4" x 6" / 10 x 15 cm	Photo	Photo Paper Plus Glossy
		Photo Paper Plus Semi-gloss
		Glossy Photo Paper
		Glossy Photo Paper "Everyday Use"
		Photo Stickers* ¹
	Fast Photo	Photo Paper Pro
5" x 7" / 13 x 18 cm ²	Photo	Photo Paper Plus Glossy

“Paper size” setting	“Paper type” setting	Paper loaded in machine
A4 / 8.5" x 11" (Letter) ^{*3, *4}	Photo	Photo Paper Plus Glossy
		Photo Paper Plus Semi-gloss
	Fast Photo	Photo Paper Pro
A4 ^{*3, *4}	Photo	Glossy Photo Paper "Everyday Use"
5.4 x 8.6 cm / Credit Card	Photo	Glossy Photo Paper

^{*1} This paper is exclusively used to print photo stickers. When printing on sticker paper, select 4" x 6" / 10 x 15 cm in “Paper size”.

^{*2} This size can be selected only for Canon PictBridge compatible devices (note that it cannot be selected for some models).

^{*3} “Plain Paper” can be selected for “Paper type” when A4 or 8.5" x 11" (Letter) is selected for “Paper size”. When “Plain Paper” is selected for “Paper type”, bordered printing will be performed even when “Borderless” is selected for “Layout”.

^{*4} When A4 or 8.5" x 11" (Letter) is selected for “Paper size”, you can print in 4-up layout.

■ About “Layout” and “Trimming”

For “Layout”, when the “Default” (selections based on the machine setting) is selected, the machine operates based on the <PICTBRIDGE SET> in [Menu] of the machine. Trimming is performed based on settings on the PictBridge compliant device.

Note

- When printing onto Photo Stickers (PS-101) (16-up), use the following settings.
 1. Select the Auto Sheet Feeder as the paper source.
For details, see “Loading the Print Media in the Auto Sheet Feeder” on page 27.
Always load Photo Stickers (PS-101) in the Auto Sheet Feeder.
 2. Select 4" x 6" / 10 x 15 cm for the “Paper size”, and “Photo” for the “Paper type”.
 3. Select N-up for layout, then select 16-up.
- Some PictBridge compliant devices display the Layout option; 2-up, 4-up, 9-up, and 16-up. In this case always select 16-up. If there are no options on the PictBridge compliant device that correspond to 2-up, 4-up, 9-up, or 16-up, printing on stickers is not possible.
- When you using Photo Stickers (PS-101), do not set “Borderless” in “Layout” settings.

■ About “Image optimize”

When the “Default” (selection based on the machine setting) is selected, the machine operates based on <PICTBRIDGE SET> in [Menu] of this machine.

If you use a Canon PictBridge compatible device, you can select “VIVID”, “NR”, “VIVID+NR” or “Face” (Note that these options cannot be selected for some models).

Note

- When “VIVID” is selected, green and blue portions of photos are printed vividly.
- When “NR” (Noise Reduction) is selected, noise in blue portions, such as the sky, and dark portions is removed.
- When “VIVID+NR” is selected, functions of both “VIVID” and “NR” are performed.
- When “Face” is selected, backlit images are corrected when printed.

■ About "Date/File No. print"

You cannot change this setting on this machine. Selections of this setting will be based on that of the PictBridge compliant device.

If you select an image which has had the shooting date embedded in it using a camera with the print mode, select "Off" for this function. If you select "Date", "File No.", or "Both", the date and/or file number will be printed over the embedded date.

Note

- Never disconnect the USB cable during printing.
- When disconnecting the USB cable between the PictBridge compliant device and machine, follow the instructions given in the device's instruction manual.
- Controls of the device cannot be used for the following:
 - Print quality setting
 - Machine maintenance

Printing Photographs Directly from a Canon Bubble Jet Direct Compatible Digital Camera

The following is a list of media types that can be set on the Canon Bubble Jet Direct compatible digital camera or digital video camcorder (PictBridge incompatible) along with their limitations when connected to this machine.

■ Media Types for Digital Camera

When you connect a digital camera, you can use the following media:

Digital Camera Setting	Media Type
Card #1	Photo Paper Pro 4" x 6" / 101.6 x 152.4 mm
Card #2	Photo Paper Plus Glossy 4" x 6" / 101.6 x 152.4 mm
	Photo Paper Plus Semi-gloss 4" x 6" / 101.6 x 152.4 mm
	Glossy Photo Paper 4" x 6" / 101.6 x 152.4 mm
	Glossy Photo Paper "Everyday Use" 4" x 6" / 101.6 x 152.4 mm
Card #3	Photo Paper Plus Glossy 5" x 7" / 127.0 x 177.8 mm
LTR	Photo Paper Pro Letter
	Photo Paper Plus Glossy Letter
	Photo Paper Plus Semi-gloss Letter
	Glossy Photo Paper Letter

Digital Camera Setting	Media Type
A4	Photo Paper Pro A4
	Photo Paper Plus Glossy A4
	Photo Paper Plus Semi-gloss A4
	Glossy Photo Paper A4
	Glossy Photo Paper "Everyday Use" A4

 **Note**

- For the digital camera operation method and troubleshooting, refer to your digital camera's manual.
- For print error messages, see "Cannot Print Properly from the Digital Camera" on page 133.
- By operating the digital camera, you can make the following prints:
 - You can make a standard print from the image displayed in the single display mode or in the index display mode.
 - You can print specified numbers of images, or make an index print by editing the DPOF. Images other than Exif may not be index printed.
 - For the images taken with an ExifPrint compatible digital camera, the ExifPrint function can be used.
 - If date printing is set from the digital camera, the date when the photograph was taken is to be printed (excluding the index print).
 - Images will be scaled automatically according to the image size set on the digital camera and the size of the media set on the machine.
- The digital camera does not support the following functions:
 - Print quality setting
 - Machine maintenance

Chapter 4

Faxing

Preparing Your Machine for Fax

■ Methods of Registering Information in Your Machine

You can set the sending and receiving settings from the Operation Panel of the machine.

■ Examples of Connecting the Machine

Typical examples of connecting the machine are described below. The machine cannot send/receive faxes if the connection is incorrect. Connect the machine correctly.

● Connecting to the Telephone Line

● Connecting to an Analog Line

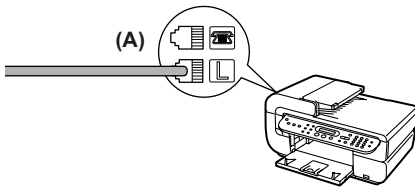

(A) Telephone line (analog)

● Connecting to an ADSL

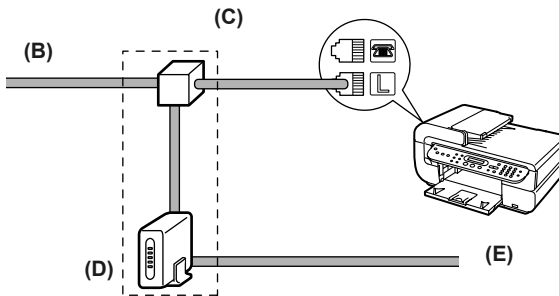

(B) Asymmetric Digital Subscriber Line

(C) Splitter

(D) ADSL modem (splitter may be built-in to the modem)

(E) Computer

For details on ADSL connection and settings, see the manual supplied with your ADSL modem. The illustrated connection is an example and is not guaranteed to suit every connecting condition.

● Connecting to an ISDN Line

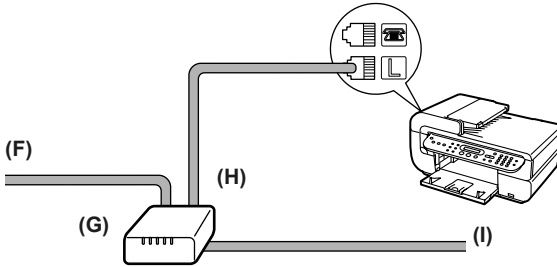

(F) ISDN line

(G) Terminal adapter, etc.

(H) Analog port

(I) Computer

For details on ISDN connection and settings, see the manuals supplied with your terminal adapter or dial-up router.

● Connecting External Devices

● Connecting a Telephone or Answering Machine via a Computer

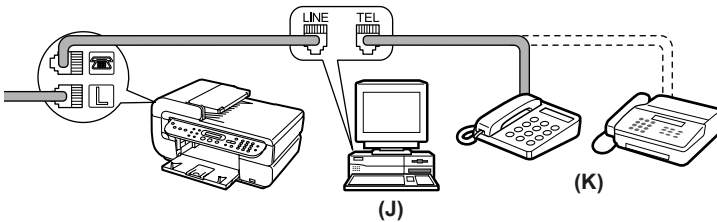

(J) Computer

(K) Telephone or answering machine

● Connecting a Telephone or Answering Machine Directly

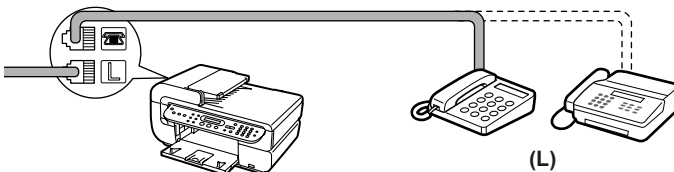

(L) Telephone or answering machine

For Users In The UK

If the connector of the external device cannot be connected to the jack on the machine, you will need to purchase a B.T. adapter to connect as follows:
Connect the external device line to the B.T. adapter, then connect the B.T. adapter to the  jack.

■ Setting the Telephone Line Type

Before using your machine, make sure you set the correct telephone line type for your telephone line. If you are unsure of your telephone line type, contact your telephone company. For ISDN (Integrated Services Digital Network) or ADSL (Asymmetric Digital Subscriber Line) connections, contact the telephone company or service provider to confirm your line type.

Note

You can print the USER'S DATA LIST to check the current setting (See "Printing the USER'S DATA LIST" on page 71).

- 1 Press [FAX], then press [Menu].
- 2 Use [◀] or [▶] to select <USER SETTINGS>, then press [OK].

```
USER SETTINGS
DATE/TIME SETTING▶
```

- 3 Use [◀] or [▶] to select <TEL LINE TYPE>, then press [OK].

```
TEL LINE TYPE
◀ *TOUCH TONE
```

- 4 Use [◀] or [▶] to select the telephone line type, then press [OK].

TOUCH TONE: Suitable for tone dialing.

ROTARY PULSE: Suitable for pulse dialing.

Note

In New Zealand, select <TOUCH TONE>. You cannot use <ROTARY PULSE>.

- 5 Press [Stop/Reset].

■ Registering Sender Information

You can register sender information (Transmit Terminal Identification (TTI)) in your machine so that your name or company name, your fax/telephone number, and the date and time of transmission are printed in small type at the top of each page to be received. Thus, whenever you send a fax from this machine, the recipient receiving the fax knows who sent it, and when it was sent.

Below is an example of how your sender information would be printed on a fax sent from your machine:

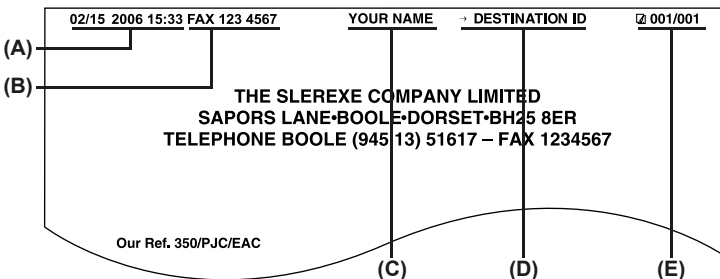

- (A) Date and time of transmission
- (B) Your fax/telephone number
 - You can select <FAX> or <TEL> to be printed in front of the number
(See "TX TERMINAL ID" on page 94).
- (C) Your name is printed.
- (D) The recipient's name is printed when sending from coded speed dialing.
- (E) Page number

 **Note**

- For black & white sending, you can set the sender information to print inside or outside the image area (See "TX TERMINAL ID" on page 94).
- For color sending, the sender information is printed inside the image area, and the DESTINATION ID is not printed.
- You can enter the sender information from the Operation Panel (See "Registering Your Fax/Telephone Number and Name (Sender Information)" on page 64).
- Three formats of date are available. For details on the date format settings, see "DATE DISPLAY" on page 93.

● Entering the Date and Time

 **Note**

- When your machine is connected to a computer with the MP driver installed, even if the date and time are entered from the Operation Panel of the machine, the date and time will be read from your computer every time you start the computer, turn the machine on, or disconnect and connect the USB cable.
When using your machine connecting to your computer, set the date and time on your computer precisely.
- The date and time will be reset when you disconnect the power cord or there is a power failure. In this case, you can set it again on the machine. Alternatively, it can be read from your computer and set on the machine by connecting the machine to your computer with the MP driver installed.

- 1 Press [FAX], then press [Menu].
- 2 Use [◀] or [▶] to select <USER SETTINGS>.
- 3 Press [OK] two times.

DATE/TIME SETTING
02/15/2006 18:46

- 4 Use the numeric buttons to enter the date and time (in 24-hour format).
Enter only the last two digits of the year.

 **Note**

- If you misentered the date and time, use [◀] or [▶] to move the cursor under the number to enter the correct number.
- Three formats of date are available. For details on the date format settings, see "DATE DISPLAY" on page 93.

- 5 Press [OK].
- 6 Press [Stop/Reset].

● **Registering Your Fax/Telephone Number and Name (Sender Information)**

- 1 Press [FAX], then press [Menu].
- 2 Use [◀] or [▶] to select <USER SETTINGS>, then press [OK].
- 3 Use [◀] or [▶] to select <UNIT TEL NUMBER>.
- 4 Press [OK].

UNIT TEL NUMBER
TEL=

- 5 Use the numeric buttons to enter your fax/telephone number (max. 20 digits, including spaces).
To enter a plus sign (+) before the number, press [#].

 **Note**

For details on how to enter or delete numbers, see “Guidelines for Entering Numbers, Letters, and Symbols” on page 68.

- 6 Press [OK].

USER SETTINGS
◀ UNIT NAME ▶

- 7 Press [OK].

UNIT NAME : A

- 8 Use the numeric buttons to enter your name (max. 24 characters, including spaces).

 **Note**

For details on how to enter or delete characters, see “Guidelines for Entering Numbers, Letters, and Symbols” on page 68.

- 9 Press [OK].
- 10 Press [Stop/Reset].

 **Note**

You can print the USER'S DATA LIST to confirm the sender information you have registered (See “USER'S DATA LIST” on page 71).

■ Registering Coded Speed Dialing

Coded speed dialing allows you to dial fax/telephone numbers by simply pressing [Coded Dial]. First, you register a fax/telephone number for coded speed dialing, then to dial the number, simply press [Coded Dial] and enter the two-digit code assigned to that number.

Before you can use coded speed dialing, you need to register the recipients' numbers.

1 Press [FAX], then press [Menu].

2 Use [◀] or [▶] to select <CODED DIAL REGIST>, then press [OK].

CODED DIAL REGIST
*00=

3 Use [◀] or [▶] to select a coded speed dialing code (00 to 39).

4 Press [OK] two times.

TEL NUMBER
TEL=

5 Use the numeric buttons to enter the fax/telephone number you want to register (max. 60 digits (40 digits for Korea), including spaces).

Note

- For details on how to enter or delete numbers, see “Guidelines for Entering Numbers, Letters, and Symbols” on page 68.
- For color sending, the recipient's name is not printed.
- Press [Redial/Pause] to enter a pause.
- Press [✕] to enter a tone.

6 Press [OK] two times.

NAME : A

7 Use the numeric buttons to enter a name for the coded speed dialing code (max. 16 characters, including spaces).

Note

For details on how to enter or delete characters, see “Guidelines for Entering Numbers, Letters, and Symbols” on page 68.

8 Press [OK].

The <CODED DIAL REGIST> screen is displayed to enter the next number.

- If you continue registering coded speed dialing codes, repeat the procedure from step 4.
- If not, go to step 9.

9 Press [Stop/Reset].

Note

For a list of the recipients you have registered, print the coded speed dialing list (See “Printing the CODED SPEED DIAL TELEPHONE NO. LIST” on page 66).

● Changing or Deleting a Coded Speed Dialing

● To change a registered number:

- (1) Follow the procedures from step 1 to 4 under “Registering Coded Speed Dialing”.
- (2) Press and hold [◀] to delete the registered number.
- (3) Use the numeric buttons to enter the new number.
- (4) Press [OK].
- (5) Press [Stop/Reset].

● To change a registered name:

- (1) Follow the procedures from step 1 to 6 under “Registering Coded Speed Dialing”.
- (2) Press and hold [◀] to delete the registered name.
- (3) Use the numeric buttons to enter the new name.
- (4) Press [OK].
- (5) Press [Stop/Reset].

● To delete an entire entry:

- (1) Follow the procedures from step 1 to 4 under “Registering Coded Speed Dialing”.
- (2) Press and hold [◀] to delete the registered number.
- (3) Press [OK].
- (4) Press [Stop/Reset].
The name will automatically be deleted when you delete the number.

■ Printing the CODED SPEED DIAL TELEPHONE NO. LIST

You can print a list of the recipients registered for coded speed dialing. You may want to keep the list near your machine to refer to it when dialing.

- 1 Press [FAX], then press [Menu].
- 2 Use [◀] or [▶] to select <PRNT REPORT/LIST>, then press [OK].

```
PRNT REPORT/LIST
  ACTIVITY REPORT ▶
```

- 3 Use [◀] or [▶] to select <SPEED DIAL LIST>.

```
PRNT REPORT/LIST
◀ SPEED DIAL LIST ▶
```

- 4 Press [OK].

```
PRINT BY NAME?
< YES >      NO
```

- 5 Use [◀] or [▶] to select the sorting way, then press [OK].

YES: Prints the list with the destination name (DESTINATION ID) in alphabetical order.

NO : Prints the list with the numerical order in ascending order.

■ Setting Daylight Saving Time (Summer Time)

Some countries adopt the daylight saving time (summer time) system that shifts the clock time forward or back at certain periods of the year.

You can set your machine to automatically change the time by registering the day and time that daylight saving (summer time) begins and ends.

Note

This setting is not available in some countries and regions.

- 1 Press [FAX], then press [Menu].
- 2 Use [◀] or [▶] to select <USER SETTINGS>, then press [OK].
- 3 Use [◀] or [▶] to select <SUMMER TIME SET>, then press [OK].

SUMMER TIME SET
*ON ▶

- 4 Use [◀] or [▶] to select <ON> or <OFF>.
 - If you select <OFF>, go to step 21.
 - If you select <ON>, go to step 5.

- 5 Press [OK] three times.

SET MONTH
◀ *MARCH ▶

- 6 Use [◀] or [▶] to select the month when summer time starts.
- 7 Press [OK] two times.

SET WEEK
*LAST WEEK ▶

- 8 Use [◀] or [▶] to select the week when summer time starts.
FIRST WEEK / SECOND WEEK / THIRD WEEK / FOURTH WEEK / LAST WEEK

- 9 Press [OK] two times.

SET DAY OF WEEK
*SUNDAY ▶

- 10 Use [◀] or [▶] to select the day of the week when summer time starts.
- 11 Press [OK] two times.

SET SHIFT TIME
02:00

- 12** Use the numeric buttons to enter the time (in 24-hour format) when summer time starts.

Precede single digit with a zero.

- 13** Press [OK] three times.

SET MONTH
*OCTOBER

- 14** Use [◀] or [▶] to select the month when summer time ends.

- 15** Press [OK] two times.

SET WEEK
*LAST WEEK

- 16** Use [◀] or [▶] to select the week when summer time ends.

FIRST WEEK / SECOND WEEK / THIRD WEEK / FOURTH WEEK / LAST WEEK

- 17** Press [OK] two times.

SET DAY OF WEEK
*SUNDAY

- 18** Use [◀] or [▶] to select the day of the week when summer time ends.

- 19** Press [OK] two times.

SET SHIFT TIME
03:00

- 20** Use the numeric buttons to enter the time (in 24-hour format) when summer time ends.

Precede single digit with a zero.

- 21** Press [OK].

- 22** Press [Stop/Reset].

■ Guidelines for Entering Numbers, Letters, and Symbols

- 1** Press [✳] to switch to uppercase letter mode (:A), lowercase letter mode (:a), or number mode (:1).

You can see what mode you are in by the character displayed on the top right corner of the LCD.

NAME	: A
------	-----

 **Note**

Lowercase letter mode (:a) may not be available, depending on the country of purchase.

2 Use the numeric buttons to enter a character. Press the button repeatedly until the character you want appears.

- **To enter successive characters from the same numeric button:**

Press the numeric button, press , then press the same numeric button again.

- **To enter a space:**

Press  two times.

In number mode, press  once.

- **To delete a character:**

Press .

- **To delete an entire entry:**

Press and hold .

Models with lowercase letter mode:

Button	Uppercase letter mode	Lowercase letter mode	Number mode
[1]			1
[2]	ABCĂĂĂĂĂĂĂÆÇ	abcăăăăăăăæç	2
[3]	DEFĚĚĚĚĚ	defěěěěě	3
[4]	GHĪĪĪĪĪ	ghīīīīī	4
[5]	JKL	jkl	5
[6]	MNOŃŃŃŃŃŃŃŃ	mnoñññññññ	6
[7]	PQRSþ	pqrsp	7
[8]	TUVÛÛÛÛÛ	tuvúúúúú	8
[9]	WXYZÝ	wxyzý	9
[0]			0
[#]	-.SP * # ! " , ; : ^ _ = / ' ? \$ % & + () [] { } < >		
[*]	Press [*] to switch to uppercase letter mode (:A), lowercase letter mode (:a), or number mode (:1).		

SP indicates a space.

Models without lowercase letter mode:

Button	Letter mode	Number mode
[1]		1
[2]	ABCabc	2
[3]	DEFdef	3
[4]	GHghi	4
[5]	JKLjkl	5
[6]	MNOmno	6

Button	Letter mode	Number mode
[7]	PQRSpqrs	7
[8]	TUVtuv	8
[9]	WXYZwxyz	9
[0]		0
[#]	-.SP*#!";,:^`_=/ '?\$@%&+()[]{}<>	

SP indicates a space.

■ Summary of Reports and Lists

The table below shows the reports and lists that can be printed from your machine. Refer to the pages indicated for more details.

Report or List	Description
ACTIVITY REPORT	Shows recent facsimile transactions performed by your machine. You can enable or disable automatic printing of this report after every 20 transactions. You can also manually set the machine to print it. See "ACTIVITY REPORT" on page 70.
CODED SPEED DIAL TELEPHONE NO. LIST	Lists the destination numbers and names registered for coded dial speed dialing. See "Printing the CODED SPEED DIAL TELEPHONE NO. LIST" on page 66.
USER'S DATA LIST	Lists the current settings of your machine and the registered sender information. See "USER'S DATA LIST" on page 71.
MEMORY LIST	Lists the documents currently stored in the machine's memory. See "Printing the MEMORY LIST" on page 76.
TX (Transmission) REPORT	Prints after transmission of a document. You can enable or disable this feature, or set the machine to print a report only when an error occurs. You can also set the machine to print the first page of the document under the transmission report to remind you of the contents of the document. See "TX REPORT" on page 71.
RX (Reception) REPORT	Prints after reception of a document. You can enable or disable this feature, or set the machine to print a report only when an error occurs. See "RX REPORT" on page 71.

■ ACTIVITY REPORT

The machine is factory-set to print an ACTIVITY REPORT after every 20 transactions. You can also select whether to print this report manually or automatically.

Note

For details on the ACTIVITY REPORT setting, see "USER SETTINGS" on page 93.

● Printing the ACTIVITY REPORT

- 1 Press [FAX], then press [Menu].
- 2 Use [◀] or [▶] to select <PRNT REPORT/LIST>, then press [OK].
- 3 Use [◀] or [▶] to select <ACTIVITY REPORT>, then press [OK].
The ACTIVITY REPORT is printed.

■ USER'S DATA LIST

The USER'S DATA LIST enables you to confirm the current settings of your machine as well as the registered sender information (See "Registering Sender Information" on page 62).

● Printing the USER'S DATA LIST

- 1 Press [FAX], then press [Menu].
- 2 Use [◀] or [▶] to select <PRNT REPORT/LIST>, then press [OK].
- 3 Use [◀] or [▶] to select <USER'S DATA LIST>, then press [OK].
The USER'S DATA LIST is printed.

■ TX REPORT

Your machine can print a TX (transmission) REPORT after sending a document. You can set the machine to print every time it sends a document, or only when an error occurs. Alternatively, you can disable printing of a report.

Note

- For details on the TX REPORT setting, see "TX SETTINGS" on page 94.
- The default setting is <PRINT ERROR ONLY>.

■ RX REPORT

Your machine can print an RX (reception) REPORT after receiving a document. You can set the machine to print every time it receives a document, or only when an error occurs. Alternatively, you can disable printing of a report.

Note

- For details on the RX REPORT setting, see "RX SETTINGS" on page 95.
- The default setting is <DO NOT PRINT>.

Sending Faxes

■ Documents You can Fax

For information on the types of documents you can fax, their requirements, and details on loading them, see "Document Handling" on page 19.

■ Flow of Sending Faxes

The operation flow of sending faxes is as follows:

Important

Color sending is available only when the recipient's fax machine supports color faxing.

Step 1

Load the document or photograph you want to send on the Platen Glass or in the ADF.



Step 2

Adjust the fax resolution and scan contrast (See "Before Sending Faxes" on page 72).



Step 3

Dial the recipient's number using the numeric buttons or coded speed dialing (See "How to Use Coded Speed Dialing" on page 75).



Step 4

When using the Platen Glass : Press [Color] or [Black], and proceed to step 5.
When using the ADF : Press [Color] or [Black] to start sending, and omit steps 5 and 6.



Step 5

For a multipage document, load the next page and press [Color] or [Black].



Step 6

Press [OK] to start sending.

■ Before Sending Faxes

The machine enables you to adjust the resolution and scan contrast to suit the type of document.

● Adjusting the Image Quality (Fax Resolution)

You can adjust the image quality (fax resolution) of the document you send. The higher the image quality, the better the output quality at the other end, but the slower the transmission speed. Adjust the image quality according to the type of document you are sending.

- 1 Press [FAX], then press [Image Quality].



2 Use [◀] or [▶] to select the resolution.

STANDARD: Suitable for text-only documents.

FINE: Suitable for fine-print documents.

PHOTO: Suitable for photographs.

 **Note**

When sending color faxes, selecting <FINE> has the same effect as selecting <PHOTO>.

3 Press [OK].

● **Adjusting the Scan Contrast**

Contrast is the degree of difference between light and dark. Increasing the contrast setting further blackens dark areas and whitens bright areas. Whereas decreasing the contrast setting reduces the difference between bright and dark areas. You can adjust the contrast between three gradations.

1 Press [FAX], then press [Exposure].



2 Use [◀] or [▶] to select the contrast.

Pressing [◀] decreases the density, and pressing [▶] increases the density.

3 Press [OK].

■ **Sending Methods**

There are three methods of sending faxes:

- Memory sending
- Manual sending
- Sending from your computer

This section explains how to use these methods.

● **Sending from Your Machine (Memory Sending)**

1 Load the document on the Platen Glass or in the ADF.

 **Important**

When sending a double-sided document, set the document on the Platen Glass. You cannot scan double-sided document from the ADF.

 **Note**

For details on document requirements and how to load documents, see “Loading Documents” on page 19.

2 Press [FAX].

3 Adjust the settings for your document as necessary.

Note

- To select the image quality (fax resolution), see “Adjusting the Image Quality (Fax Resolution)” on page 72.
- To select the scan contrast, see “Adjusting the Scan Contrast” on page 73.

- 4** Dial the recipient’s number (DESTINATION NUMBER) using the numeric buttons or coded speed dialing.

Note

For details on how to use coded speed dialing, see “How to Use Coded Speed Dialing” on page 75.

- 5** Press [Color] for color sending, or [Black] for black & white sending.

● When the document was loaded on the Platen Glass:

- (1) When the following message is displayed, load the next page on the Platen Glass.

SCAN NEXT	→ [START]
TRANSMIT	→ [OK]

If you have only one sheet of document to scan, press [OK].

- (2) Press [Color] to send in color, or [Black] to send in black and white. Press the same button you pressed in step 5.

Important

If you do not press the same button you pressed in step 5, the machine does not start scanning.

● When the document was loaded in the ADF:

The machine starts sending automatically after the document is scanned in.

Important

Color sending is available only when the recipient’s fax machine supports color faxing.

Note

- To cancel sending before sending a fax, press [Stop/Reset].
- To cancel memory sending while sending a fax, follow any instructions on the LCD after pressing [Stop/Reset].
- If the document remains in the ADF after pressing [Stop/Reset] during sending a fax, press [OK]. The remaining document is automatically fed out.

● Sending from Your Machine (Manual Sending)

Use manual sending when you want to talk to the recipient before sending a document, or if the recipient does not have a fax machine that can receive automatically.

Important

- If you select <GERMANY> in the <COUNTRY SELECT> when installing your machine, the manual sending is not available. You need to execute the memory sending. For details on memory sending, see “Sending from Your Machine (Memory Sending)” on page 73.
- With manual sending, you cannot use the Platen Glass to send documents.
- You will need to connect a telephone to your machine if you want to talk to the recipient before sending a document.

- 1 Connect a telephone to your machine if you want to talk to the recipient before sending a document.
- 2 Load the document in the ADF.

 **Note**

For details on how to load documents, see “Loading Documents” on page 19.

- 3 Press [FAX].
- 4 Adjust the settings for your document as necessary.

 **Note**

- To select the image quality (fax resolution), see “Adjusting the Image Quality (Fax Resolution)” on page 72.
- To select the scan contrast, see “Adjusting the Scan Contrast” on page 73.

- 5 You can lift the handset if an answering machine is connected to the machine.
- 6 Dial the recipient’s number using the numeric buttons or coded speed dialing.

 **Note**

For details on how to use coded speed dialing, see “How to Use Coded Speed Dialing” on page 75.

- 7 Talk through the handset to the recipient.
If you hear a high-pitched signal instead of the recipient’s voice, go to step 9.

- 8 Ask the recipient to set recipient’s fax machine to receive faxes.

- 9 When you hear a high-pitched signal, press [Color] for color sending, or [Black] for black & white sending. Then hang up the handset.

 **Important**

Color sending is available only when the recipient’s fax machine supports color faxing.

 **Note**

To cancel manual sending, press [Stop/Reset].

Windows

● **Sending Faxes from Your Computer**

With your machine connected to your computer, you can send faxes from the computer. For details, refer to the *FAX Driver Guide*.

■ **How to Use Coded Speed Dialing**

Pre-registering fax numbers in coded speed dials enables you to dial them by just pressing [Coded Dial] and entering a two-digit code.

- 1 Press [Coded Dial].

- 2 Use the numeric buttons to enter the two-digit code (00-39) assigned to the number you want to dial, then press [OK].

■ Redialing a Busy Number

There are two methods of redialing: Manual redialing and Automatic redialing.

● Manual Redialing

To redial the fax number last dialed with the numeric button, press [Redial/Pause].

Note

- For details on memory sending, see “Sending from Your Machine (Memory Sending)” on page 73.
- To cancel manual redialing, press [Stop/Reset].

● Automatic Redialing

When using memory sending to send a document and the recipient's line is busy, your machine will redial the number after a specified interval.

Note

- Your machine enables you to customize automatic redialing settings to suit your needs.
- To cancel automatic redialing, wait until the machine starts redialing, then press [Stop/Reset]. Follow the instructions on the LCD.
- You can also delete the document from memory. For details, see “Printing or Deleting a Document in Memory” on page 77.

Customizing Automatic Redialing Settings

You can customize the following settings:

- You can specify whether or not your machine redials automatically by setting <AUTO REDIAL> under <TX SETTINGS> to <ON> or <OFF>.
- You can specify the number of times the machine redials by setting <REDIAL TIMES> after <AUTO REDIAL> is set to <ON>.
- You can specify the time interval between redialings by setting <REDIAL INTERVAL> after <REDIAL TIMES> is specified.

Note

For details on the redialing settings, see “TX SETTINGS” on page 94.

■ Documents Stored in Memory

Caution

If you disconnect the power cord, all the documents stored in memory are deleted. Send or print all the documents stored in memory you do not wish to lose before disconnecting the power cord.

● Printing the MEMORY LIST

The machine can print a list of documents stored in memory (MEMORY LIST) showing the transaction number (TX/RX NO.), transaction mode, recipient name, number of pages, date, and transmission time of each document. This will help you select a document in memory you wish to delete or print.

- 1 Press [FAX], then press [Menu].

2 Use [◀] or [▶] to select <MEMORY REFERENCE>.

3 Press [OK] two times.

The MEMORY LIST is printed.

 **Note**

- If there are no documents stored in memory, the machine will switch to the standby mode after <NO DOC. IN MEMORY> is displayed.
- In step 2, you can also print this list from <MEMORY LIST> in <PRNT REPORT/LIST> of the FAX SETTINGS menu (See “PRNT REPORT/LIST” on page 93).

● **Printing or Deleting a Document in Memory**

1 Press [FAX], then press [Menu].

2 Use [◀] or [▶] to select <MEMORY REFERENCE>.

3 Press [OK].

4 Use [◀] or [▶] to select <PRINT DOCUMENT> or <DELETE DOCUMENT>.

● **If you select <PRINT DOCUMENT>:**

(1) Press [OK].

(2) Use [◀] or [▶] to select the transaction number (TX/RX NO.) of the document you want to print, or enter the number using the numeric buttons.

If you are unsure of the transaction number, print the MEMORY LIST (See “Printing the MEMORY LIST” on page 76).

(3) Press [OK].

(4) Use [◀] to select <YES> to print the first page only, or use [▶] to select <NO> to print all pages of the document.

(5) Press [OK].

(6) To print another document, return to branch-step 2, or to finish printing, go to step 5.

● **If you select <DELETE DOCUMENT>:**

(1) Press [OK].

(2) Use [◀] or [▶] to select the transaction number (TX/RX NO.) of the document you want to delete, or enter the number using the numeric buttons.

(3) Press [OK].

(4) Use [◀] to select <YES> to delete document, or use [▶] to select <NO> not to delete the document.

(5) Press [OK].

(6) To delete another document, return to branch-step 2, or to finish deleting, go to step 5.

5 Press [Stop/Reset].

● **Checking a Document's Details in Memory**

If the machine was not able to print a received fax, as when paper or ink has run out or a paper jam has occurred, the fax is automatically stored in memory. When selecting a document in memory to be printed or deleted, you can check its details on the LCD as follows:

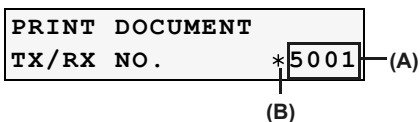

(A) Transaction number (TX/RX NO.)

- A transaction number between 0001 and 4999 is a document being sent.
- A transaction number between 5001 and 9999 is a document being received.

(B) Marks before the transaction number

- No mark indicates a black & white document.
- <✳> indicates a color document.
- <#> indicates a black & white document being sent or printed.
- <&> indicates a color document being sent or printed.

Displaying Details of the Transaction

Use [~~*~~] or [#] to display the details (e.g. transaction number, transaction time and fax number).

Note

If you are unsure of the transaction number, print the MEMORY LIST (See "Printing the MEMORY LIST" on page 76).

■ Special Dialing

● Dialing through a Switchboard

A PBX (Private Branch Exchange) is an on-site telephone switchboard. If your machine is connected through a PBX or other telephone switching system, you have to dial the outside line access number first, and then the number of the party you are calling.

● Sending/Receiving Using ECM

This machine is set to send/receive faxes in ECM (Error Correction Mode). Checking the sending and receiving condition at the sending end and the receiving end respectively, ECM automatically corrects errors caused by telephone line trouble.

Note

- If the sender's or receiver's fax is not ECM-compatible, the fax will be sent/received in the standard mode.
- You can also disable ECM sending/receiving (See "TX SETTINGS" on page 94).

Receiving Faxes

■ Flow of Receiving Faxes

The operation flow of receiving faxes is as follows:

Step1

Load paper in the Auto Sheet Feeder (See “Loading the Print Media in the Auto Sheet Feeder” on page 27).

Load paper in the Cassette (See “Loading the Print Media in the Cassette” on page 31).

- The paper size should be A4, LTR or LGL.
- Load legal-size paper in the Auto Sheet Feeder.



Step2

Select the receive mode (See “Receive Modes” on page 80).

- If you want to receive only faxes automatically with your machine, or you have a dedicated telephone line for fax use only:<FAX ONLY MODE>
- If you receive mainly voice calls and sometimes faxes, or you want to receive faxes manually:<MANUAL MODE>
- If you want to receive voice messages on your answering machine and receive faxes automatically:<ANS.MACHINE MODE>
- If you want to receive faxes automatically as well as voice calls:<FAX/TEL AUTO SW>
- If you have subscribed to a Distinctive Ring Pattern Detection (DRPD) service with your telephone company (US and Canada only):<DRPD>
- If you want your machine to automatically switch between fax and voice calls by the calling patterns (Network Switch) (This setting is not available in some countries and regions.):<NETWORK SWITCH>

Note

- You have to connect a telephone to the External Device Jack when you set <MANUAL MODE>, <FAX/TEL AUTO SW>, <NETWORK SWITCH>, or <DRPD>.
- You have to connect an answering machine to the External Device Jack when you set <ANS.MACHINE MODE>.

■ Paper Size and Type

Load A4- or letter-size plain paper in the Auto Sheet Feeder or Cassette when you print the fax.

Important

- Load legal-size paper in the Auto Sheet Feeder.
- If the paper size is set to a setting other than <A4> or <8.5 x 11>, the received faxes will not be printed, and the LCD will display <CHANGE PAPER TO> and <RECEIVED IN MEMORY>. Change the paper size setting to <A4> or <8.5 x 11>, and then press [OK].
- If a size of paper other than A4, 8.5 x 11 or 8.5 x 14 is loaded in the paper source specified under [Feed Switch], only one sheet of the loaded paper is printed and <CHECK PAGE SIZE> is displayed. Replace the paper loaded in the specified paper source with A4, 8.5 x 11 or 8.5 x 14 then press [OK].
- The auto feed function can be applied when the paper size for both paper sources is set to <A4> or <8.5 x 11>. See “About the Auto Sheet Feeder and Cassette” on page 24.

Note

If the sender sent documents larger than letter-size (8.5" x 11"), such as 11" x 17" or legal-size (8.5" x 14"), the sender's machine may send the fax, automatically shrinking or dividing it, or send only a part of the original.

■ Receive Modes

Select the receive mode according to your needs.

Important

The machine cannot receive faxes when the power is turned OFF. Press [ON/OFF] to turn the power ON.

Note

The machine can receive faxes in any mode, such as copy mode (when [COPY] is pressed), fax mode (when [FAX] is pressed), or scan mode (when [SCAN] is pressed). However, when the machine received faxes in other than fax mode, they will not be printed immediately after received but printed after about three minutes automatically. If you want to print the received faxes immediately, press [FAX].

● If You Want to Receive Only Faxes Automatically with Your Machine, or You Have a Dedicated Telephone Line for Fax Use Only:

● Select <FAX ONLY MODE >.

- When you receive a fax call: The machine will receive the fax automatically.
- When you receive a voice call: You will not be able to answer the call.

Note

The telephone does not ring when it receives a fax call. If you want it to ring, connect a telephone to your machine and enable the <INCOMING RING> setting (see "INCOMING RING" on page 95). You can also select the number of rings before the machine answers (See "INCOMING RING" on page 95).

● If You Receive Mainly Voice Calls and Sometimes Faxes, or You Want to Receive Faxes Manually:

● Select <MANUAL MODE>.

- When you receive a fax call: The telephone will ring. Pick up the handset and if you hear a high-pitched signal, press [Black] or [Color] on the machine to receive the fax.
- When you receive a voice call: The telephone will ring. Pick up the handset to answer the call.
- For remote receiving: If you are far from your machine, dial 25 (the remote receiving ID) on your telephone to receive faxes.

Note

- The machine can receive faxes automatically after the telephone rings for a specified length of time (See “MAN/AUTO SWITCH” on page 96).
- You can customize remote receiving by enabling/disabling it, or by changing the remote receiving ID (See “REMOTE RX” on page 96).
- If you have an answering machine connected to your machine that can carry out remote-control operations (controlling your answering machine from a remote telephone), the security code for this function may be the same as the remote receiving ID. If so, make sure you change the machine’s remote receiving ID to make it distinct from the answering machine’s security code (See “REMOTE RX” on page 96).
- If the paper is not set on the sending side, your machine will go into the reception standby mode.

● If You Want to Receive Voice Messages on Your Answering Machine and Receive Faxes Automatically:

● Select <ANS.MACHINE MODE>.

- When you receive a fax call: First the answering machine connected to your machine will respond to an incoming call, and then the machine will receive faxes automatically.
- When you receive a voice call: The answering machine connected to your machine will respond to an incoming call.

Adjusting The Answering Machine

Adjust your answering machine as follows:

- Set the answering machine to answer on the first or second ring.
- The entire message should be no longer than 15 seconds.
- In the message, tell your callers how to send a fax.

Note

The machine can receive faxes automatically after the telephone rings for a specified length of time (See “MAN/AUTO SWITCH” on page 96).

● If You Want to Receive Faxes Automatically as well as Voice Calls:

● Select <FAX/TEL AUTO SW>.

- When you receive a fax call: The machine will receive the fax automatically.
- When you receive a voice call: The machine will ring. Pick up the telephone or answering machine connected to your machine to answer the call.

Note

The telephone does not ring when it receives a fax call. If you want it to ring, connect a telephone to your machine and enable the <INCOMING RING> setting (see “INCOMING RING” on page 95). You can also select the number of rings before the machine answers (See “INCOMING RING” on page 95).

Customizing FAX/TEL AUTO SW

You can customize this mode to control precisely how your machine handles incoming calls. You can adjust the time the machine takes to check whether a call is a fax or voice

call, the length of time the machine rings when it is a voice call, and the action the machine must take if no one answers a voice call.

Note

For details on the FAX/TEL AUTO SW settings, see “FAX/TEL AUTO SW” on page 95.

● **If You Have Subscribed to a Distinctive Ring Pattern Detection (DRPD) Service with Your Telephone Company (US and Canada only):**

● **Select <DRPD>.**

- When you receive a fax call: The machine will ring according to the ring pattern you have chosen and receive the fax automatically.
- When you receive a voice call: The telephone will ring according to the ring pattern you have chosen. Pick up the handset of your answering machine to answer the call.

Setting the Ring Pattern

Your telephone company will assign a distinctive ring pattern to each number when you order the DRPD service. Set the fax ring pattern that matches the pattern assigned by the telephone company.

● **If You Want Your Machine to Automatically Switch between Fax and Voice Calls by the Call Ring Patterns (Network Switch) (This setting is not available in some countries and regions.):**

● **Select <NETWORK SWITCH>.**

The machine identifies whether a call is fax or not by ringing tone and receives it.

- When you receive a fax call: The machine will ring and receive the fax automatically.
- When you receive a voice call: The telephone will ring. Pick up the handset to answer the call.

Note

- The name of this service varies depending upon a country. The typical example is as follows:

Australia: NET SWITCH

New Zealand: FAX ABILITY

Finland: Own Ringing

- To use this feature, you need to subscribe to a compatible service provided by your telephone company. Contact your telephone company for details.

■ **Setting the Receive Mode**

1 Press [FAX], then press [Menu].

2 Press [OK].

RECEIVE MODE SET
◀ *FAX ONLY MODE ▶

3 Use [◀] or [▶] to select the receive mode.

FAX ONLY MODE:	See "If You Want to Receive Only Faxes Automatically with Your Machine, or You Have a Dedicated Telephone Line for Fax Use Only:" on page 80.
MANUAL MODE:	See "If You Receive Mainly Voice Calls and Sometimes Faxes, or You Want to Receive Faxes Manually:" on page 80.
ANS.MACHINE MODE:	See "If You Want to Receive Voice Messages on Your Answering Machine and Receive Faxes Automatically:" on page 81.
FAX/TEL AUTO SW:	See "If You Want to Receive Faxes Automatically as well as Voice Calls:" on page 81.
DRPD:	See "If You Have Subscribed to a Distinctive Ring Pattern Detection (DRPD) Service with Your Telephone Company (US and Canada only):" on page 82.
NETWORK SWITCH:	See "If You Want Your Machine to Automatically Switch between Fax and Voice Calls by the Call Ring Patterns (Network Switch) (This setting is not available in some countries and regions.):" on page 82.

4 Press [OK].

The receive mode will be displayed on the bottom left of the LCD.

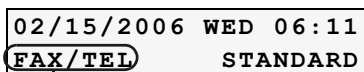

(A)

(A) Receive mode

Note

For details on the receive modes, see "Receive Modes" on page 80.

■ Canceling Receiving

Press [Stop/Reset] and follow any instructions on the LCD.

■ Memory Receiving

If ink has run out while receiving a fax, if ink level is low, if the <SIZE> setting is incorrect, or if the <TYPE> setting is other than <PLAIN>, the fax is automatically stored in memory and <RECEIVED IN MEMORY> is displayed. When the ink tank is replaced or the paper size setting is corrected, the stored fax is printed automatically.

Note

- The machine can store up to approximately 150 pages* of faxes in memory.
- If the memory becomes full, the machine cannot receive the remaining faxes. Print or delete the documents stored in memory (see "Printing or Deleting a Document in Memory" on page 77), and then contact the sender and have him/her resend them.

* When using ITU-T No.1 chart (Standard mode)

Chapter 5

Printing from Your Computer

This section describes the basic printing procedure, taking the steps to print documents as an example.



Printing with Windows

Note

- Menu and command names may differ between application softwares, and more steps may be required. For details, refer to the documentation for each application software you use.
- The steps described in this section are for printing in Windows XP Service Pack 2 (hereafter, called Windows XP SP2).
- If your machine is connected to a computer, you can send faxes using the fax driver from any application software that has a printing function. For details, refer to the *FAX Driver Guide*.

1 Press [ON/OFF] to turn on the machine.
See “Turning on the Machine” on page 18.

2 Load the paper in the machine.
See “Loading Paper” on page 22.

3 Ensure that the proper paper source is selected.
When the Auto Sheet Feeder Lamp (A) lights, paper is fed from the Auto Sheet Feeder.
When the Cassette Lamp (B) lights, paper is fed from the Cassette.

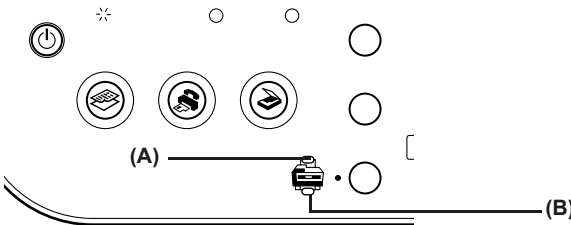

Note

Press [Feed Switch] so that the Auto Sheet Feeder Lamp lights when loading paper in the Auto Sheet Feeder and the Cassette Lamp lights when loading paper in the Cassette.

4 Create a document or open a file to print from the application software.

5 Open the printer properties dialog box.

- (1) Select [Print] from the application software's [File] menu.
The [Print] dialog box opens.
- (2) Ensure that your machine is selected.

Note

If another name of the machine is selected, click the name of the machine to use.

(3) Click [Preferences] or [Properties].

The [Main] tab of the [Printing Preferences] screen is displayed.

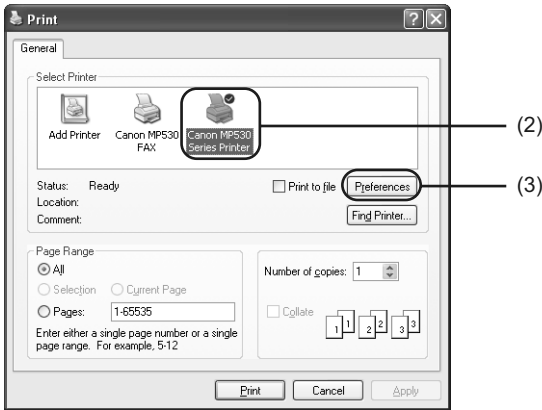

6 Specify the required settings.

(1) Click [Media Type] to select the type of media loaded in the machine.

(2) Ensure that [Paper Feed Switch] is selected from [Paper Source].

(3) Specify the print quality and other settings in [Print Quality] or [Color/Intensity].

Note

For print settings, refer to the *Printer Driver Guide*.

(4) Click [OK].

The [Printing Preferences] screen is closed.

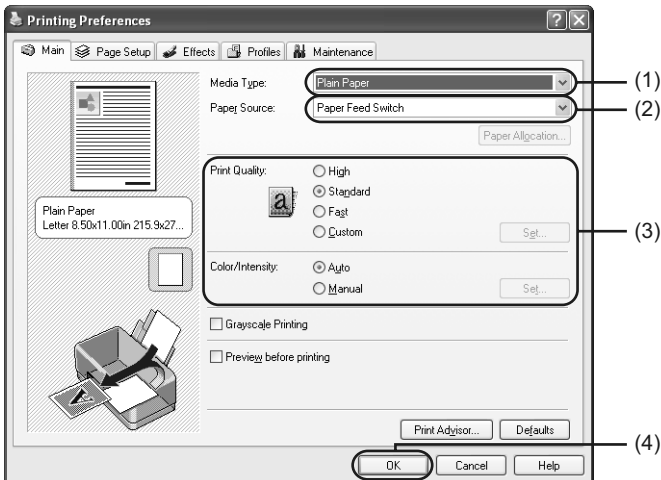

Note

- To confirm the page size, click on the [Page Setup] tab. If it does not match the document size set by the application software, select the matching page size.
- This section describes the procedure for selecting [Paper Feed Switch] from [Paper Source]. For a detailed description of the [Paper Source] settings, refer to the *Printer Driver Guide*.
- For details about other printer driver functions, click [Instructions] or [Help] to view the *Printer Driver Guide*. [Instructions] is only displayed when the *Printer Driver Guide* is installed.
- Selecting the [Preview before printing] check box displays a preview screen that allows you to confirm the selected printing effects and how your document will look when printed. Some application softwares do not have a preview function.

7 Click [Print] or [OK].

The machine starts printing.

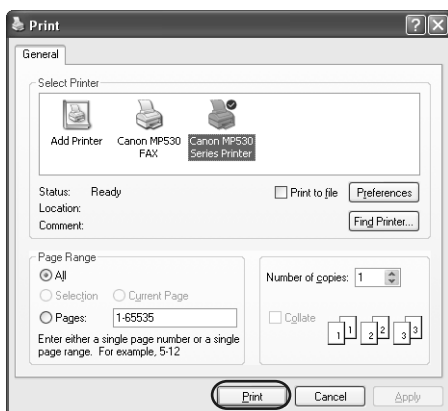

Note

- You can cancel a print job in progress by simply pressing [Stop/Reset] on the machine.
- Click [Cancel Printing] on Canon IJ Status Monitor to stop printing. To show Canon IJ Status Monitor, click [Canon MP530 Series Printer] on the taskbar.

Macintosh

Printing with Macintosh

Note

- Menu and command names may differ between application softwares, and more steps may be required. For details, refer to the documentation for each application software you use.
- The steps described in this section are for printing in Mac[®] OS X v.10.4.

1 Press [ON/OFF] to turn on the machine.
See “Turning on the Machine” on page 18.

2 Load the paper on the machine.

See “Loading Paper” on page 22.

3 Ensure that the proper paper source is selected.

When the Auto Sheet Feeder Lamp (A) lights, paper is fed from the Auto Sheet Feeder.

When the Cassette Lamp (B) lights, paper is fed from the Cassette.

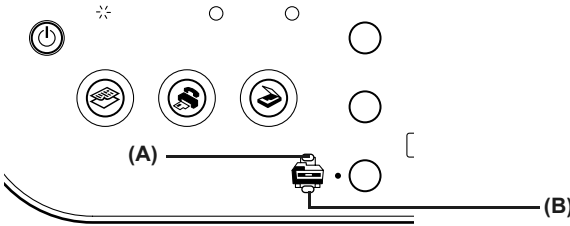

Note

Press [Feed Switch] so that the Auto Sheet Feeder Lamp lights when loading paper in the Auto Sheet Feeder and the Cassette Lamp lights when loading paper in the Cassette.

4 Create a document or open a file to print from the application software.

5 Select the paper size.

- (1) Select [Page Setup] from the application software's [File] menu. The [Page Setup] dialog box opens.
- (2) Select [MP530] from [Format for].
- (3) Select the desired page size from [Paper Size].
- (4) Click [OK].

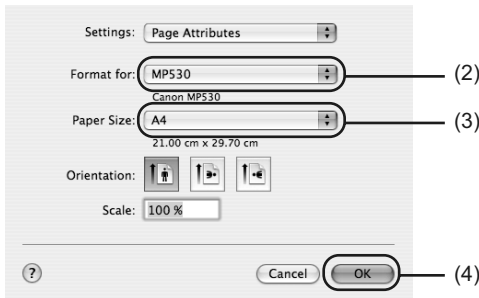

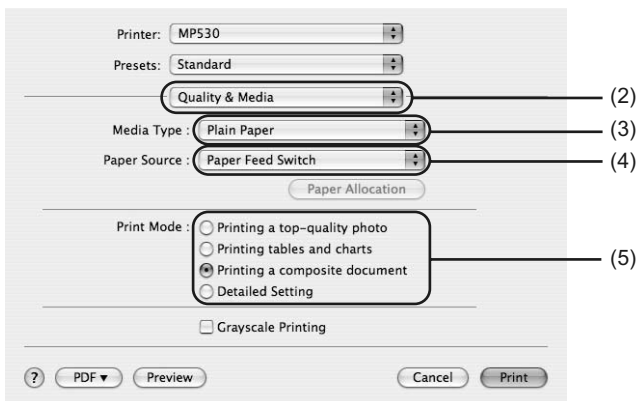

6 Specify the required settings.

- (1) Select [Print] from the application software's [File] menu. The [Print] dialog box opens.
- (2) Select [Quality & Media] from the pop-up menu.
- (3) Select the desired media type from [Media Type].
- (4) Ensure that [Paper Feed Switch] is selected from [Paper Source].
- (5) Select the print mode appropriate to your document from [Print Mode].



Note

- This section describes the procedure for selecting [Paper Feed Switch] from [Paper Source]. For a detailed description of the [Paper Source] settings, refer to the *Printer Driver Guide*.
- When you select the print mode appropriate to your document from [Print Mode], the document will be printed in color and at a print quality suited to the characteristics of the [Media Type] you have selected.
 - [Printing a top-quality photo]: Select when printing documents consisting mainly of photographs and graphics featuring fine color gradation.
 - [Printing tables and charts]: Select when printing documents consisting mainly of graphs and graphics (illustrations) with strong color definition.
 - [Printing a composite document]: Select when printing documents consisting mainly of text.
 - [Detailed Setting]: Select to fine-tune the [Print Quality] and [Halftoning] settings.
- For details about other printer driver functions, click  to view the *Printer Driver Guide*. If the *Printer Driver Guide* is not installed, the *Printer Driver Guide* is not displayed even if  is clicked.
- Clicking [Preview] displays a preview screen that allows you to confirm the selected printing effects and how your document will look when printed. Some application softwares do not have a preview function.

7 Click [Print].

The machine starts printing.

Note

Double-clicking the name of your machine in the [Printer list] of the [Printer Setup Utility] (When using Mac OS X v.10.2, double-clicking the name of your machine in the [Printer list] of the [Print Center]) displays a dialog that prompts you to confirm the status of the print job(s). To cancel a job in progress, select the desired document, then click [Delete]. To temporarily stop a job in progress, click [Hold]. To stop all the jobs in the list, click [Stop Jobs] (when using Mac OS X v.10.3 or Mac OS X v.10.2, click [Stop Printing]).

Chapter 6

Scanning Images

This section describes how to scan images.

About Scanning Images

You can scan images from the machine into a computer, and save them in JPEG, TIFF, or Bitmap format. Then you can process that data by using the supplied application software to create original images. Furthermore, you can use the supplied OCR (Optical Character Recognition) software to convert scanned paper documents to text data.

■ Before Scanning

Before scanning images, confirm as follows:

- Are the necessary software (MP Drivers and MP Navigator) installed?
If the software is not yet installed, refer to the *Easy Setup Instructions*.
- Does the document to be scanned meet the requirements for an original to set on the Platen Glass or in the ADF?
For details, see "Document Requirements" on page 19.
- Is the machine connected to your computer correctly?
Make sure your machine and computer are correctly connected with the USB cable.

Scanning Methods

■ Scanning Using the MP Navigator

Using the MP Navigator, you can scan, process and save documents to your computer.

Windows

On the Windows desktop, double-click the [MP Navigator 2.2] icon to open the MP Navigator.

Macintosh

On the [Go] menu, select [Applications], then double-click the [MP Navigator 2.2] icon to open the MP Navigator.

You can launch the following application software from the MP Navigator.

- Easy-PhotoPrint (Photo Printing)
- Presto! PageManager (Organizing photos and documents)
- ScanSoft OmniPage SE (Converting scanned document to text)*

* This application software may not be supplied with this machine in some countries and regions.

Note

- If you performed the [Custom Install] and only installed the MP Driver and MP Navigator, these application software were not installed and thus cannot be launched. To launch any of the above application software from MP Navigator, perform the [Custom Install] once again to install them.
- ScanSoft OmniPage SE does not support Windows 98 first edition.
- You can also open the MP Navigator from the Operation Panel. For details on using the MP Navigator, refer to the *Scan Guide*.

■ **Scanning from an Application Software**

You can scan an image from TWAIN- or WIA- (Windows XP only) compliant application software and use the image in that application software. This procedure varies depending on the application software.

For the detailed procedure, refer to the manual of the application software you are using.

Changing the Machine Settings

Changing the Settings

This section describes the procedure to change the settings on <DEVICE SETTINGS>, taking the steps to specify <EXTENDED AMOUNT> as an example.

- 1 Press [ON/OFF] to turn on the machine.
See "Turning on the Machine" on page 18.
- 2 Press [Menu] repeatedly to select <DEVICE SETTINGS>.
- 3 Select the menu.
 - (1) Use [◀] or [▶] to select the setting item, then press [OK].
Example: select <PRINT SETTINGS>.
The setting screen for the selected item is displayed.

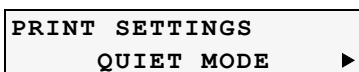

- (2) Use [◀] or [▶] to select the menu, then press [OK].
Example: select <EXTENDED AMOUNT>.

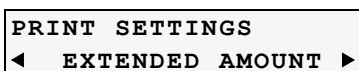

- 4 Change the settings.
 - (1) Use [◀] or [▶] to select the setting item, then press [OK].
Example: select <SMALL>.

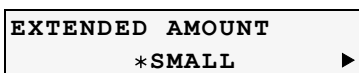

PRINT SETTINGS

■ QUIET MODE

Use this function if you want to reduce the operation noise, such as when printing at night.

● Important

- The printing speed may be reduced compared to when this setting is set to <OFF>.
- This function may not be so effective depending on the print quality setting.
- Furthermore, certain noise, such as when the machine is preparing for printing, is not reduced.

■ PREVENT ABRASION

Use this setting only if the print surface becomes smudged.

Important

Be sure to revert this setting to <OFF> after printing since it may result in lower print quality.

■ EXTENDED AMOUNT

Selects the amount of image that extends off the paper when printing in Borderless (full).

Note

If you set <LARGE> for this function, the area of the image extending off the paper becomes larger.

■ AUTO FEED SWITCH

If the Auto Sheet Feeder or Cassette runs out of paper, the paper source automatically switches to the other one.

Important

- This function only works when both paper sources are loaded with paper of the same size and type.
- When printing from a computer, you need to set this feature with the printer driver. For details, refer to the *Printer Driver Guide*.
- When printing from a computer, this feature can be used only when both paper sources are loaded with paper other than Credit Card- or Legal-sized paper.
- In Copy mode, this feature can be used only when both paper sources are loaded with paper other than Credit Card- or Legal-sized paper.
- In Fax mode, this feature can be used only when both paper sources are loaded with A4- or Letter-sized plain paper.

Note

For the limit number of paper to load into the Auto Sheet Feeder and Cassette, see the table in “Changing the Page Size and Media Type” on page 37.

FAX SETTINGS

Before changing any settings, you can print the USER'S DATA LIST to check the current settings of your machine. For details, see “Printing the USER'S DATA LIST” on page 71.

■ RECEIVE MODE SET

● FAX/TEL AUTO SW

Selects <FAX/TEL AUTO SW> receive mode.

● FAX ONLY MODE

Selects <FAX ONLY MODE> receive mode.

● DRPD

Selects <DRPD> receive mode. This setting is only available in US and Canada.

● NETWORK SWITCH

Selects <NETWORK SWITCH> receive mode. This setting is not available in some countries and regions.

● MANUAL MODE

Selects <MANUAL MODE> receive mode.

- **ANS.MACHINE MODE**

Selects <ANS.MACHINE MODE> receive mode.

- **MEMORY REFERENCE**

- **PRINT MEMORY LIST**

Prints the MEMORY LIST.

- **PRINT DOCUMENT**

Selects a document stored in memory and prints it.

PRINT 1ST PAGE ONLY?: You can select pages to be printed. Select <YES> to print only the first page of the document. Select <NO> to print all the pages of the document.

- **DELETE DOCUMENT**

Deletes a document in memory.

- **PRNT REPORT/LIST**

- **ACTIVITY REPORT**

Prints the ACTIVITY REPORT.

- **SPEED DIAL LIST**

Prints the CODED SPEED DIAL TELEPHONE NO. LIST.

PRINT BY NAME?: You can select the order of the destination numbers and names printed in the list. Select <YES> to print the list with the destination names in alphabetical order. Select <NO> to print the list with the numerical order (00-39) in ascending order.

- **USER'S DATA LIST**

Prints the USER'S DATA LIST.

- **MEMORY LIST**

Prints the MEMORY LIST.

- **CODED DIAL REGIST**

- **CODED DIAL REGIST**

Registers coded speed dialing.

- **USER SETTINGS**

- **DATE/TIME SETTING**

Sets the current date and time.

- **DATE DISPLAY**

Selects the date format displayed on the LCD and printed on faxes you send.

Three date formats are available; <YYYY/MM/DD>, <MM/DD/YYYY>, and <DD/MM/YYYY>.

- **SUMMER TIME SET**

Enables/disables the summer time setting. If you select <ON>, you can select additional sub-settings (This setting is not available in some countries and regions).

START DATE/TIME:	Sets the date and time that summer time starts.
SET MONTH	Specify the month.
SET WEEK	Specify the week.
SET DAY OF WEEK	Specify the day of the week.
SET SHIFT TIME	Specify the 24 hours.
END DATE/TIME:	Sets the date and time that summer time ends.
SET MONTH	Specify the month.
SET WEEK	Specify the week.
SET DAY OF WEEK	Specify the day of the week.
SET SHIFT TIME	Specify the 24 hours.

● UNIT TEL NUMBER

Enters the fax/telephone number printed on faxes you send.

● UNIT NAME

Enters the name printed on faxes you send.

● TX TERMINAL ID

Prints sender information at the top of each fax you send (The ON/OFF setting may be available depending on the county of purchase).

TTI POSITION:	Selects the position of the sender information (outside or inside the image area) when sending black & white faxes (Automatically set inside the image area for color faxes).
FAX/TEL NO. MARK:	Selects the mark to appear before the fax/telephone number printed on faxes you send.

● OFFHOOK ALARM

Enables/disables the alarm that alerts you if the handset of the telephone connected to the machine is not hung up properly.

● VOLUME CONTROL

Sets the RX RING VOLUME and LINE MONITOR VOL.

RX RING VOLUME:	When the machine is set to ring, selects the ring volume.
LINE MONITOR VOL.:	Selects the line monitor volume while dialing.

● RX RING LEVEL

Selects the ring type for incoming call.

● TEL LINE TYPE

Selects the telephone line type setting for your machine.

Note

In New Zealand, select <TOUCH TONE>. You cannot use <ROTARY PULSE>.

● ACTIVITY REPORT

Sets whether to print the ACTIVITY REPORT automatically after every 20 transactions.

■ TX SETTINGS

● ECM TX

Enables/disables Error Correction Mode (ECM) sending.

● PAUSE TIME

Selects the pause length when you press [Redial/Pause].

● AUTO REDIAL

Enables/disables automatic redialing.

REDIAL TIMES: If you select <ON> as <AUTO REDIAL>, enables setting the number of redialings.

REDIAL INTERVAL: If you select <ON> as <AUTO REDIAL>, enables setting the length of time between redialings.

● TX START SPEED

Selects the speed at which the machine starts transmitting.

● COLOR TX

When faxing in color from the ADF, enables/disables automatic converting the image into black and white before sending if the destination fax device does not support color.

● TX REPORT

Enables/disables automatic printing of a transmission report after sending.

ATTACH TX IMAGE: If you select <PRINT ERROR ONLY> or <PRNT FOR EACH TX> as <TX REPORT>, enables/disables printing the first page of the fax under the report (black & white faxes only).

● DIAL TONE DETECT

If you selects <ON>, the machine transmits after confirming the dial tone. This function may not be supported depending on your country or area.

■ RX SETTINGS

● ECM RX

Enables/disables Error Correction Mode (ECM) during reception.

● FAX/TEL AUTO SW

If you select <FAX/TEL AUTO SW> as the receive mode, customizes its settings.

RING START TIME: Selects the time the machine takes to check whether a call is a fax or voice call.

TEL RING TIME: Selects the ring length for voice calls.

DEFAULT ACTION: Selects whether the machine switches to receive mode after the ring time has elapsed, or whether it disconnects the call.

● DRPD:FAX RNG PAT

If you select <DRPD> as the receive mode, select the ring pattern for the machine. This setting is only available in US and Canada.

● INCOMING RING

If you select <FAX/TEL AUTO SW>, <DRPD> or <FAX ONLY MODE> as the receive mode, enables/disables ringing for fax calls (A telephone must be connected to your machine for ringing to occur).

RING COUNT: If you select <ON> as <INCOMING RING>, selects the number of rings for fax calls.

● **MAN/AUTO SWITCH**

If you select <MANUAL MODE> or <ANS. MACHINE MODE> as the receive mode, enables/disables the machine to switch to fax receive mode after ringing for a specified length of time.

RX START TIME: Selects the length of time the machine rings before switching to fax receive mode.

● **REMOTE RX**

Enables/disables remote receiving.

If you select <ON>, selects the remote receiving ID.

● **RX IMG REDUCTION**

Enables/disables automatic reduction of faxes to fit the paper loaded.

REDUC. DIRECTION: If you select <ON> as <RX IMG REDUCTION>, enables selecting the direction of the reduction.

● **RX START SPEED**

Selects the speed at which the machine starts receiving.

● **RX REPORT**

Enables/disables automatic printing of a reception report after receiving.

If you select <PRINT ERROR ONLY> or <PRINT FOR EACH RX>, prints a reception report only when a print error occurred or every time you receive a fax.

OTHERS

■ **AUDIBLE TONES**

Selects the volume.

● **KEYPAD VOLUME**

Selects the beep volume when pressing the buttons on the Operation Panel.

● **ALARM VOLUME**

Selects the alarm volume.

■ **PWR SAVE SETTING**

Specifies the time to switch the machine to the Power Saver mode.

■ **COUNTRY SELECT**

Selects the country where you are using your machine. This setting is not available in some countries and regions.

■ **LANGUAGE SETTING**

Selects the language for LCD messages.

RESTORE DEFAULT

You can change the settings back to the settings on your purchase (some data may not be reset depending on your usage condition).

SAVE CONFIG

Saves the settings for the Settings screen.

LOAD CONFIG

Loads the settings for the Settings screen that were saved.

Chapter 8

Routine Maintenance

Replacing an Ink Tank

When ink runs out, replace the ink tank. The machine will not print if the wrong type of ink tank is used, or if it is installed in the incorrect position.

The machine uses the following ink tanks.

Black: CLI-8BK



Magenta: CLI-8M



Black: PGI-5BK





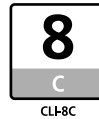

Cyan: CLI-8C



Yellow: CLI-8Y



Note

- Be sure to install the ink tanks in the correct order. The proper arrangement from the left is Black , Black , Yellow , Magenta , Cyan .
- Should missing characters or white streaks appear despite sufficient ink levels, see “When Printing Becomes Faint or Colors are Incorrect” on page 103.

Getting the Ink Level Information

You can check the ink tank status by the ink lamp display. Open the Scanning Unit (Printer Cover) of the machine and check the ink lamp.

When the ink level is low:

The ink lamp flashes slowly (about three seconds). Prepare a new ink tank.



When ink has run out:

The ink lamp flashes fast (about one second). Replace it with a new ink tank.



If an error message is displayed on the LCD, an ink tank error has occurred and the machine cannot continue to print. See “An Error Message is Displayed on the LCD” on page 113.

Knowing When to Replace Ink Tank

It is necessary to identify the empty ink tank by checking the message displayed on the LCD and replace it.

Note

Should missing characters or white streaks appear despite sufficient ink levels, see “When Printing Becomes Faint or Colors are Incorrect” on page 103.

The message <INK LOW> appears on the LCD when the ink level becomes low during printing.

- Press [OK] to continue printing.
- Press [Stop/Reset] to cancel the current print job.

Note

It's recommended that the tank should be replaced with a new one as soon as possible.

The message <CHECK INK> appears on the LCD when ink becomes empty during printing.

- If printing has not finished, you can continue printing for a while by pressing [OK] with the empty ink tanks installed. However, you will need to replace it with a new one as soon as printing finishes. If you continue printing with an empty ink tank, it may damage the machine.
- Press [Stop/Reset] to cancel printing. Replace the ink tank with a new one. Printing will resume as soon as the ink tank is replaced and the Scanning Unit is closed.

Note

- Be sure to press [OK] with all the ink tanks installed. Printing does not resume if any of the ink tanks are left uninstalled.
- If you continue to print with an empty ink tank, the ink level will not be detected correctly.
- If an error message is displayed on the LCD, an ink tank error has occurred and the machine cannot continue to print. See “An Error Message is Displayed on the LCD” on page 113.

Replacing Ink Tanks

When an ink tank runs out of ink, replace it using the following steps.

Note

- To maintain optimal print quality, use an ink tank within six months of its first use.
- Once an ink tank has been used, do not remove it from the machine and leave it out in the open. This will cause the ink tank to dry out and the machine may not operate properly if it is reinstalled.
- Color ink consumption may occur even when black-and-white or grayscale printing is specified. Color ink is consumed in the head cleaning and deep cleaning, which are necessary to maintain the machine's capabilities.
- Do not replace ink tanks during scanning in documents. If you open the Scanning Unit (Printer Cover) during scanning in, documents may not be scanned in properly.

1 Ensure that the machine is on.

2 Raise the Scanning Unit (Printer Cover) until it stops.

The Paper Output Tray will open automatically and the Print Head Holder moves to the center.

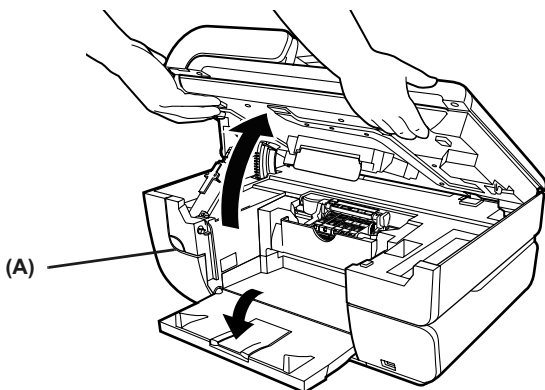

(A) Press the Open Button to open the Paper Output Tray if it does not open automatically.

Important

If the Scanning Unit (Printer Cover) is left open for more than 10 minutes, the Print Head Holder moves to the right. Close and reopen the Scanning Unit (Printer Cover) to return the Print Head Holder to the center.

3 Open the Inner Cover.

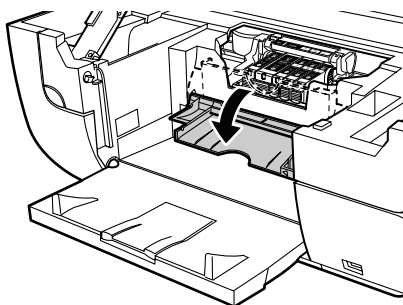

4 Push the tab (A) and remove the ink tank whose lamp is flashing red fast. Do not touch the Print Head Lock Lever (B). Remove only the ink tank.

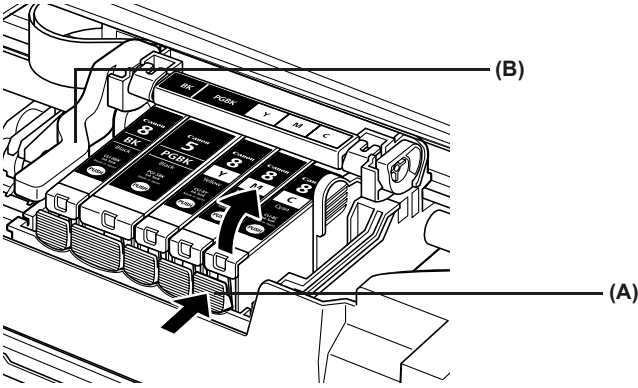

⚠ Important

- Handle ink tanks carefully to avoid staining clothing or the surrounding area.
- Discard empty ink tanks according to the local laws and regulations regarding disposal of consumables.

📖 Note

Be sure to replace ink tanks one by one when replacing more than one ink tank.

5 Prepare a replacement tank.

- (1) Remove the new ink tank from its packaging, then pull the orange tape (A) toward the arrow so that the protective film does not remain on the air hole (C). Then remove the film (B).
- (2) Remove the orange protective cap (D) from the bottom of the ink tank and discard it.

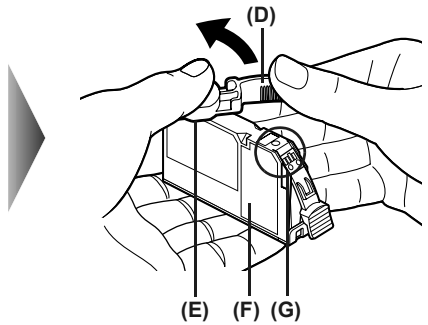
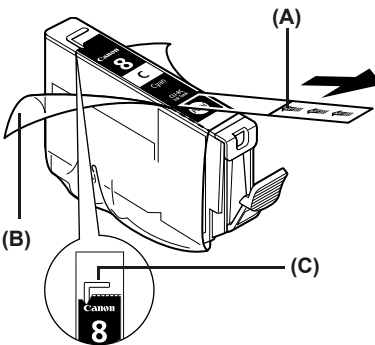

Important

- Be sure to remove the clear film from the ink tank in the exact order shown in step 5, as failure to follow this step may cause the ink to leak and stain your clothes and hands.
- Do not touch the electrical contacts (G). Doing so can cause the machine to malfunction or become unable to print.
- Do not squeeze the side of ink tanks (F) as this may cause the ink to leak out and stain your clothes and hands.
- Do not re-attach the protective cap (D) once you have removed it.
- Do not touch the open ink port (E) once the protective cap is removed, as this may prevent the ink from being ejected properly.
- Ink on the removed protective cap may stain your clothes and hands.
- Ensure that all the orange tape has been peeled off along the perforation. If there remains a part of the orange tape, ink may not be ejected correctly.

6 Install the ink tank.

- (1) Install the ink tank into the Print Head.
- (2) Press on the  mark on the ink tank until the ink tank snaps firmly into place.
- (3) Ensure that the ink tank clicks into place and then its lamp lights red (A).

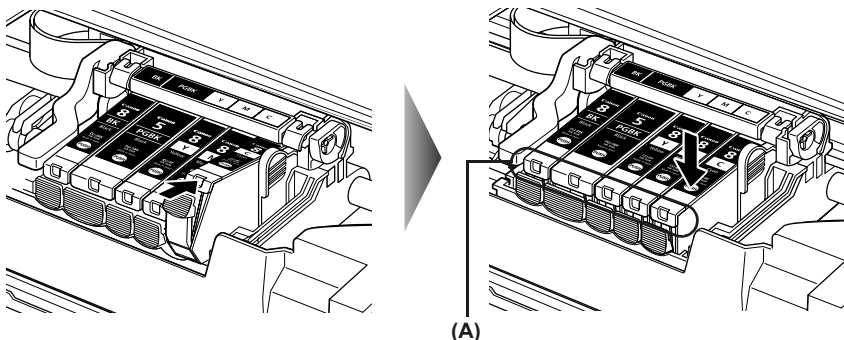

Important

Make sure to install all the ink tanks to enable printing. The machine cannot be used unless all the ink tanks are installed.

7 Close the Inner Cover.

Note

Ensure that the Inner Cover is closed. Printing will not occur if the Inner Cover is open.

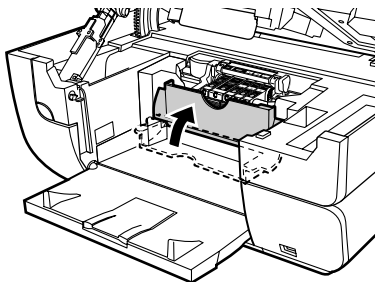

8 Slowly close the Scanning Unit (Printer Cover).

Caution

Be sure to hold the Scanning Unit (Printer Cover) firmly using both hands, and be careful not to get your fingers caught.

Note

- If <CHECK INK> is displayed on the LCD after the Scanning Unit (Printer Cover) is closed, some ink tanks may be installed in the wrong positions. Open the Scanning Unit (Printer Cover) and make sure that all the ink tanks are installed in the correct order directed on the label.
- When you start printing after replacing the ink tank, the machine executes Print Head cleaning automatically. Do not perform any other operations until the Print Head cleaning finishes.

When Printing Becomes Faint or Colors are Incorrect

When printing becomes faint or colors are incorrect, even if ink remains in the ink tanks, the Print Head nozzles are probably clogged. Follow the procedures below to clean the nozzles.

If the ruled lines are shifted after running the Print Head maintenance, align the Print Head.

Note

Before printing the nozzle check pattern or cleaning the Print Head, check the following;

- Open the Scanning Unit (Printer Cover), and make sure that all the ink tanks click into place and then their lamps light red.
- If any one of the lamps is flashing, the associated ink tank is empty or running low. See “Replacing Ink Tanks” on page 99.

If an ink lamp is flashing even though ink remains in that ink tank, it is inserted in the wrong position. Make sure that the correct ink tank color is inserted in each position. Open the Scanning Unit (Printer Cover) and make sure all the ink lamps light. See “Replacing an Ink Tank” on page 98.

- If the ink lamp cannot light, press the  mark on the ink tank firmly until it clicks to fully insert it. Make sure that all packaging material is peeled off the ink tank. See “Replacing Ink Tanks” on page 99.

Step 1

See "Printing the Nozzle Check Pattern" on page 104

If missing lines or white stripes appear



Step 2

See "Print Head Cleaning" on page 105

If the problem remains after performing Print Head cleaning twice



Step 3

See "Print Head Deep Cleaning" on page 106

After Print Head cleaning, print the nozzle check pattern.



Note

If [Print Head Deep Cleaning] does not resolve the problem, contact the Canon Customer Care Center.

● If the ruled lines are shifted

Step 1

See "Aligning the Print Head Automatically" on page 106

Printing the Nozzle Check Pattern

Print the nozzle check pattern to determine whether the ink ejects properly from the Print Head nozzles and to verify Print Head alignment. Use this function when printed results are blurred or the color is incorrect.

Note

Ensure that the Inner Cover is closed.

- 1** Press [ON/OFF] to turn on the machine, then load a sheet of A4 or Letter-sized plain paper in the Auto Sheet Feeder or Cassette.
See "Turning on the Machine" on page 18 and "Loading Paper" on page 22.
- 2** Use [Feed Switch] to select the paper source where you have loaded paper.
- 3** Printing the nozzle check pattern.
 - (1) Press [COPY].
 - (2) Press [Menu] repeatedly to select <4.MAINTENANCE>.

- (3) Use [◀] or [▶] to select <NOZZLE CHECK> and then press [OK].
The nozzle check pattern is printed.

- 4 Examine the pattern and take the appropriate action.
See “Examining the Nozzle Check Pattern” on page 105.

■ Examining the Nozzle Check Pattern

Examine the nozzle check pattern. Perform cleaning if necessary.

📖 Note

If the ink level is low, the nozzle check pattern is not printed correctly. Replace the relevant ink tank (See “Replacing an Ink Tank” on page 98).

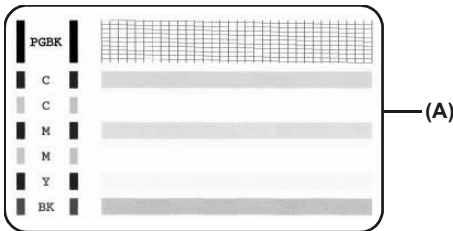

- If the lines are broken (1), or white lines are present (2) in the pattern (A), clean the print head (See “Print Head Cleaning” on page 105).

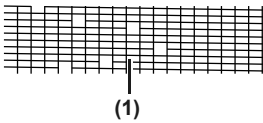

(1)



(2)

Print Head Cleaning

Clean the Print Head if missing lines or white stripes appear in the nozzle check pattern. This unclogs the nozzles to restore the Print Head condition. Note that cleaning the Print Head causes waste ink to be absorbed in the waste ink absorber. Cleaning the Print Head consumes ink, so perform Print Head cleaning only when necessary.

📖 Note

Ensure that the Inner Cover is closed.

- 1 Ensure that the machine is on.
- 2 Start the Print Head cleaning.
 - (1) Press [COPY].
 - (2) Press [Menu] repeatedly to select <4.MAINTENANCE>.
 - (3) Use [◀] or [▶] to select <CLEANING>, then press [OK].
The machine starts the Print Head cleaning.

Important

Do not perform any other operations until the Print Head cleaning finishes. This takes about 40 seconds.

3 Check the status of the Print Head.

After Print Head cleaning finishes, the nozzle check confirmation screen is displayed. Print the nozzle check pattern to verify that the Print Head nozzles are clean. See “Printing the Nozzle Check Pattern” on page 104.

Note

If you perform cleaning and nozzle check twice and the result does not improve, then perform Deep cleaning.

See “Print Head Deep Cleaning” on page 106.

Print Head Deep Cleaning

If print quality does not improve by standard Print Head cleaning, try Print Head deep cleaning, which is a more powerful process. Print Head deep cleaning consumes more ink than standard Print Head cleaning, so perform this procedure only when necessary.

Note

Ensure that the Inner Cover is closed.

1 Ensure that the machine is on.

2 Start Print Head deep cleaning.

(1) Press [COPY].

(2) Press [Menu] repeatedly to select <4.MAINTENANCE>.

(3) Use [◀] or [▶] to select <DEEP CLEANING>, then press [OK].
The machine starts the Print Head deep cleaning.

Important

The process takes about 75 seconds to complete, so simply wait until the Alarm Lamp stops flashing.

3 Check the status of the Print Head.

(1) Print the nozzle check pattern to verify that the Print Head nozzles are clean.
See “Printing the Nozzle Check Pattern” on page 104.

When one specific color only does not print, see “Replacing an Ink Tank” on page 98.

(2) If the problem remains, make sure that ink remains in the ink tank. Then turn off the machine’s power for at least 24 hours, and perform deep cleaning of the Print Head again.

(3) If the problem still remains, the Print Head may be damaged. Contact the Canon Customer Care Center.

Aligning the Print Head Automatically

If ruled lines are misaligned or a printout is unsatisfactory, adjust the Print Head position.

Print Head alignment is performed automatically. However, you can align the Print Head manually if the results of automatic Print Head alignment are not satisfactory (See “Adjusting the Print Head Manually” on page 117).

Note

- The Cassette does not feed paper for aligning the Print Head. Load paper in the Auto Sheet Feeder.
- Ensure that the Inner Cover is closed.

- 1** Press [ON/OFF] to turn on the machine.
See “Turning on the Machine” on page 18.
- 2** Press the Open button to open the Paper Output Tray, and open up and set the extension by pressing down the hollow on the front side.
- 3** Execute automatic Print Head alignment.
 - (1) Press [COPY].
 - (2) Press [Menu] repeatedly to select <4.MAINTENANCE>.
 - (3) Load a few sheets of A4- or Letter-sized plain paper in the Auto Sheet Feeder.
 - (4) Use [◀] or [▶] to select <AUTO HEAD ALIGN>, then press [OK].
A pattern is printed and the Print Head is automatically aligned. It takes about five minutes to finish printing the pattern.

Note

- The pattern is printed in black and blue.
- You can print the current adjustment values by selecting <HEAD ALIGN PRINT>.

When Automatic Print Head Aligning Cannot Be Executed Correctly

- When automatic Print Head aligning cannot be executed correctly, the message <HEAD ALIGNMENT ERROR> is displayed on the LCD.
See “An Error Message is Displayed on the LCD” on page 113.

Cleaning Your Machine

This section describes the necessary cleaning procedures for your machine.

Caution

- Be sure to turn OFF the power and disconnect the power cord before cleaning the machine.
- Do not use tissue paper, paper towels, or similar materials for cleaning. Paper tissue powders or fine threads may remain inside the machine and cause problems such as a blocked Print Head and poor printing results. Use a soft cloth to avoid scratching the components.
- Never use volatile liquids such as thinners, benzene, acetone, or any other chemical cleaner to clean the machine; these can damage the machine's components.

■ Cleaning the Platen Glass and Document Cover

Wipe the Platen Glass (D), the inner side of the Document Cover (white area) (C), the transparent sheet (A), and the inner side of the ADF (white area) (B) with a clean, soft, lint-free cloth moistened with water. Then wipe with a clean, soft, dry, lint-free cloth making sure not to leave any residue, especially on the Platen Glass. If you have trouble getting the scanning area clean, wipe with diluted mild detergent (for dish washing).

Important

The sheet (C) is easily damaged, so wipe it gently.

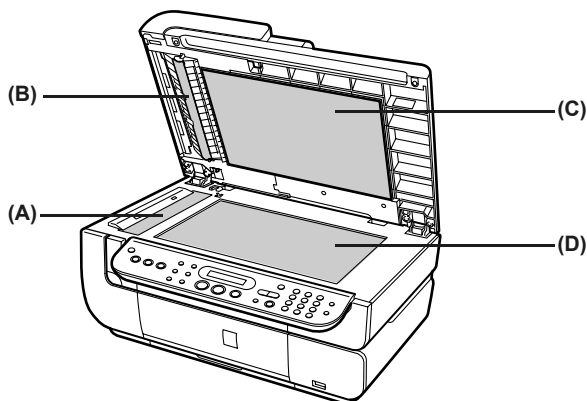

■ Cleaning the ADF

Wipe off any paper dust from the inside of the Feeder Cover as illustrated by gray colored part, with a soft, clean, lint-free and dry cloth.

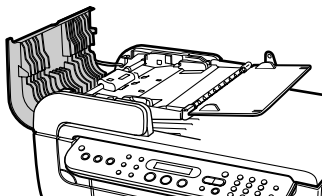

■ Cleaning the Roller (Roller Cleaning)

Clean the paper feed rollers if paper is not fed properly. Cleaning the paper feed rollers will wear the rollers, so perform this only when necessary.

Note

Ensure that the Inner Cover is closed.

- 1 Press [ON/OFF] to turn on the machine, then remove any paper from the Auto Sheet Feeder and Cassette.
See "Turning on the Machine" on page 18.
- 2 Use [Feed Switch] to select the paper source to clean.
- 3 Clean the paper feed rollers.
 - (1) Press [COPY].
 - (2) Press [Menu] repeatedly to select <4.MAINTENANCE>.
 - (3) Use [◀] or [▶] to select <ROLLER CLEANING>, then press [OK].
The paper feed rollers are cleaned.

- 4 Repeat step 3 two times.
- 5 Press the Open button to open the Paper Output Tray, and open up and set the extension by pressing down the hollow on the front side.
- 6 Load three or more of A4- or Letter-sized paper in the paper source you selected in step 2.
- 7 Repeat step 3 three times.
The sheet of paper is automatically fed in and then out of the machine.
If there are no signs of improvement after performing three times, contact the Canon Customer Care Center.

■ Cleaning the Interior of the Machine (Bottom Plate Cleaning)

This section describes how to clean the interior of the machine. If the interior of the machine becomes dirty, paper printed onto by the machine may get dirty, so we recommend performing cleaning regularly.

Note

Ensure that the Inner Cover is closed.

- 1 Press [ON/OFF] to turn on the machine, then remove any paper from the Auto Sheet Feeder.
See "Turning on the Machine" on page 18.
- 2 Press the Open button to open the Paper Output Tray, and open up and set the extension by pressing down the hollow on the front side.
- 3 Prepare a single sheet of A4- or Letter-sized plain paper. Fold it in half along the long edge. Unfold the paper, then load it in the Auto Sheet Feeder with the open side to the front.

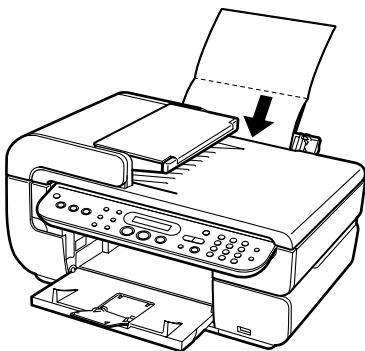

- 4 Start bottom plate cleaning.
 - (1) Press [COPY].
 - (2) Press [Menu] repeatedly to select <4.MAINTENANCE>.
 - (3) Use [◀] or [▶] to select <BOTTOM CLEANING>, then press [OK].
The sheet of paper is automatically fed in and then out of the machine.

If the printed paper is smudged, clean the inside of the machine again.

If the problem remains after performing cleaning again, the protrusions inside the machine may be stained. Clean them up. See “Cleaning the ADF” on page 108.

Important

- Even if the Cassette is selected as the paper source, paper will be fed from the Auto Sheet Feeder.
- Do not perform any other operation while the bottom plate is being cleaned.

■ Cleaning the Protrusions inside the Machine

If protrusions inside the machine are stained, wipe ink off the protrusions using a swab or the like.

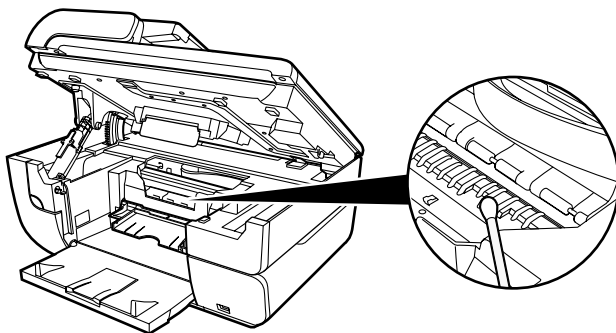

Chapter 9

Troubleshooting

This section describes troubleshooting tips for problems you may encounter when using the machine.

Note

This section describes about error messages that are displayed on the LCD or troubleshooting tips for the problems of copy or print without a computer. If you cannot find appropriate tips for your problem, refer to the On-screen Manuals.

- “If the Power Disconnects Unexpectedly” on page 113
- “An Error Message is Displayed on the LCD” on page 113
 - “Fax Related Messages” on page 118
- “Cannot See the Display on the LCD” on page 119
- “Ink Does Not Come Out/Printing is Blurred/Colors are Wrong/White Streaks/Straight Lines are Misaligned/Cannot Print to End of Job” on page 119
 - “When Copying” on page 122
- “Back of Paper is Smudged/Paper Does Not Feed Properly/Printed Surface is Scratched” on page 122
 - “Paper Curls/Ink Blots” on page 126
- “Paper Jams” on page 127
- “Document Jams” on page 130
- “Cannot Print Properly from the Digital Camera” on page 133
- “Cannot Install the MP Drivers” on page 135
- “Cannot Connect to Computer Properly” on page 137
 - “Printing Speed is Slow/USB 2.0 Hi-Speed Connection Does Not Work” on page 137

Windows

- “When You Connect to a Computer Running Windows XP, the Screen Shows the Warning Message “This device can perform faster” or “High-SPEED USB Device Plugged into non-High-SPEED USB Hub”” on page 137
- “Problems Receiving Faxes” on page 138
 - “Cannot Receive a Fax/Cannot Print a Fax” on page 138
 - “Cannot Receive Faxes Automatically” on page 139
 - “Machine Does Not Switch Automatically between Voice and Fax Calls” on page 139
 - “Quality of Received Fax is Poor” on page 139
 - “Repeated Errors Occur When You Receive a Fax” on page 139
- “Problems Sending Faxes” on page 140
 - “Cannot Send a Fax” on page 140
 - “Cannot Send a Fax Clearly” on page 140
 - “Repeated Errors Occur When You Send a Fax” on page 141
- “Telephone Problems” on page 141
 - “Cannot Dial” on page 141
 - “Telephone Disconnects During a Call” on page 141
- “Problems Scanning” on page 141
 - “Scanner Won’t Work” on page 141

- “ScanGear MP Won’t Start” on page 141
- “Computer Stops Operating During Scanning” on page 143
- “Scan Quality is Poor (Poor Image Displayed on the Monitor)” on page 143
- “Parts of Image Missing or Surrounded by Extra White Areas” on page 144
- “Trouble Scanning with Multi-Scan or Multi-Crop Function” on page 144
- “Slow Scanning Speed” on page 144

Macintosh

- ““There is not enough memory.” Message is Displayed” on page 144
- “Scanned Image not Displayed Properly” on page 145
- “Trouble scanning with MP Navigator” on page 145
- “Image position and size incorrect when scanning from the machine’s operation panel” on page 145
- “Scanned image is slanted although document is set properly” on page 145
- “Scanned image is rotated although document is set properly” on page 145
- “An Error Message Appears on the Screen” on page 146

Windows

- “Service Error 5100 is Displayed” on page 146

Windows

- “Writing Error/Output Error/Communication Error” on page 146
- “When an Error is Displayed Regarding Automatic Duplex Printing” on page 147

Macintosh

- “Error No.: 300 is Displayed” on page 147

Macintosh

- “Error No.: 1700 is Displayed” on page 148

Macintosh

- “Error No.: 1851 is Displayed” on page 148

Macintosh

- “Error No.: 1856 is Displayed” on page 148

Macintosh

- “Error No.: 2001 is Displayed” on page 149

Macintosh

- “Error No.: 2500 is Displayed” on page 149

Windows

- “For Windows Users” on page 149

Windows

If an error occurs when the machine is connected to a computer

When an error occurs in printing such as the printer is out of paper or paper jams, a troubleshooting message is displayed automatically. Take the appropriate action described in the message. The message may vary depending on the version of your Windows operating system.

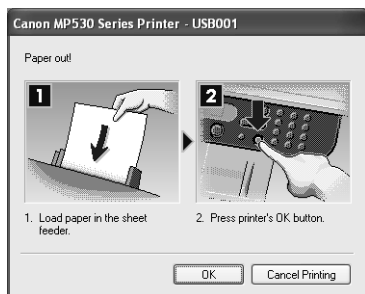

If the Power Disconnects Unexpectedly

The date and time setting on your device and all documents stored in memory will be deleted if there is a power failure or if you accidentally disconnect the power cord. However user data and coded speed dialing settings will be kept.

If the power disconnects, the following will apply:

- You will not be able to send or receive faxes or make copies.
- If a telephone is connected to the machine, you can receive voice calls.
- Whether you are able to make voice calls or not depends on your telephone type.

An Error Message is Displayed on the LCD

An error message is displayed on the LCD, take the corresponding countermeasure described below.

Message	Action
CANNOT SCAN FROM ADF	The document is loaded in the ADF when applying <FIT-TO-PAGE> in [Enlarge/Reduce], and <STICKER COPY> and <BORDERLESS COPY> in <1.SPECIAL COPY>. Load the document on the Platen Glass when copying with <FIT-TO-PAGE> in [Enlarge/Reduce], and <STICKER COPY> and <BORDERLESS COPY> in <1.SPECIAL COPY>.
CHANGE PAPER TO	The paper size setting is set to a size other than A4, letter or legal. Set the paper size setting to A4, letter or legal and load paper of the same size.
CHECK CARTRIDGE U051 U052	Follow the directions given in the <i>Easy Setup Instructions</i> to install the Print Head. If the Print Head is already installed, remove the Print Head and reinstall it. If this error still remains, the Print Head may be damaged. Contact a Canon Customer Center.
CHECK DOCUMENT	No document in the ADF. Press [OK] to resolve the error, then operate again after loading documents.

Message	Action
<p>CHECK INK U041</p>	<p>The ink has run out (The lamp on the ink tank flashes). Replace the ink tank, and close the Scanning Unit (Printer Cover). If printing is in progress and you want to continue printing, press the [OK] with the ink tank installed. Then printing can continue under the ink out condition. Replace the empty ink tank immediately after the printing. The machine may be damaged if printing is continued under the ink out condition.</p> <p> Note If multiple ink lamps are flashing red, check how fast they flash. Fast flashing (at about one second interval) indicates the ink is empty. Slow flashing (at about three second interval) indicates ink is low. For details on different flashing speeds, see “Getting the Ink Level Information” on page 98.</p>
<p>CHECK INK U071 U072</p>	<p>Possible causes are as follows:</p> <ul style="list-style-type: none"> ● Some ink tanks are not installed in place. ● More than one ink tanks of the same color are installed. <p>Confirm that the ink tanks are installed in the appropriate positions. See “Replacing an Ink Tank” on page 98.</p>
<p>CHECK INK U130</p>	<p>An ink tank that was once empty is installed. Replace the ink tank. Printing under the situation may damage the Print Head. Canon shall not be liable for any machine malfunction or damage caused by refilled ink tanks. If you want to continue printing with the refilled ink tank installed, press and hold the [Stop/Reset] for at least 5 seconds, and then release it. Using refilled ink tanks are memorized. * This operation will release the function for detecting the remaining ink level.</p>
<p>CHECK INK U140 U043</p>	<p>Possible causes are as follows:</p> <ul style="list-style-type: none"> ● The ink tank may not be installed properly (The lamp on the ink tank is off). <p>Install the appropriate ink tank.</p> <ul style="list-style-type: none"> ● The ink tank may not be compatible with this machine (The lamp on the ink tank is off). <p>Install the appropriate ink tank. See “Replacing an Ink Tank” on page 98.</p>
<p>CHECK INK U150</p>	<p>Ink tank errors have occurred (The lamp on the ink tank is off). Replace the ink tank. See “Replacing an Ink Tank” on page 98.</p>
<p>CHECK PAGE SIZE</p>	<p>The size of the page in the Auto Sheet Feeder or Cassette and that specified in the page size setting are different. Load the correct page size or change the page size setting. Then press [OK].</p>
<p>CHECK PRINTER</p>	<p>An error requiring servicing might have occurred. Turn OFF the machine, and unplug the power cord of the machine from the power supply. After a while, plug the power cord of the machine back in and turn ON the machine. If the same error occurs, contact a Canon Customer Care Center.</p>

Message	Action
<p>CLEAR DOC. →[OK] STOP DOC CLR →[STOP]</p>	<p>Documents remain in the ADF. Press [OK] to eject documents and press [Stop/Reset] to stop ejecting. To continue scanning, operate on the application. The scanning from the ADF may not be supported depending on your application software. For details, contact the application's manufacturer.</p>
<p>COOLING HEAD...</p>	<p>During printing, the Print Head may have become too hot. Allow the machine to cool down. The machine will resume printing when it has cooled down.</p>
<p>COVER IS OPEN</p>	<p>You opened the Scanning Unit during an operation. Return the Scanning Unit to its original position.</p>
<p>DEVICE IN USE CANNOT TURN OFF</p>	<p>You are unable to turn OFF the machine with [ON/OFF] because the machine is performing an operation. The machine is performing an operation. Wait until the operation has finished, then turn OFF the machine.</p>
<p>DOCUMENT IN ADF</p>	<p>The document is jammed in the ADF. Remove the document page jammed in the ADF, then press [OK]. Operate again after resolving the error. See "Document Jams" on page 130.</p>
<p>DOCUMENT TOO LONG</p>	<p>The document is too long or is jammed in the ADF. Remove the document page jammed in the ADF, then press [OK]. After resolving the error, make sure that the document you are loading meets the machine's requirements before redoing the operation. See "Document Requirements" on page 19.</p>
<p>DUPLEX UNIT JAM</p>	<p>The Duplexing Transport Unit is jammed. Clear the paper jam. Then load paper in the Auto Sheet Feeder or the Cassette, then press [OK].</p>
<p>HEAD ALIGNMENT ERROR</p>	<ul style="list-style-type: none"> ● A4/Letter-sized paper is not loaded on the Auto Sheet Feeder. Press the [OK] on the machine to clear the error, then load a few sheets of A4/Letter-sized paper in the Auto Sheet Feeder. Automatic head alignment cannot be performed using paper from the Cassette. For automatic Print Head alignment, always load paper in the Auto Sheet Feeder. ● Print Head nozzles are clogged. Press the [OK] to resolve the error. Print the nozzle check pattern to check the status of the Print Head. ● The Paper Output Slot has been exposed to a strong light source preventing current Print Head alignment. Press the [OK] to resolve the error. Adjust the printer position so the Paper Output Slot will not be exposed directly to a strong light source. <p>After carrying out the above measures, if the problem continues after aligning the Print Head again, press the [OK] to resolve the error, and then perform manual Print Head alignment. For details on manual Print Head alignment, see "Adjusting the Print Head Manually" on page 117.</p>

Message	Action
INCOMPATIBLE CAMERA DISCONNECT CAMERA CABLE	<p>Disconnect the camera cable, and reconnect it.</p> <p>Depending on the model or brand of your device, you may have to select a print mode compliant with PictBridge before connecting the camera. You may also have to turn on the camera or select Play mode manually after connecting the camera to the machine. Perform necessary operations according to the instruction manual supplied with your camera.</p> <p>If the error is still unresolved, there is a possibility that you are using a digital camera or digital video camcorder that is not supported by this machine. Use a digital camera or digital video camcorder compatible with this machine.</p>
INK LOW	<p>The ink level becomes low during printing.</p> <p>Press [OK] to continue printing or press [Stop/Reset] to cancel the current print job.</p>
INNER COVER IS OPEN	<p>If the Inner Cover is open when starting normal printing, close it before pressing [OK] on the machine.</p>
LOAD PAPER	<p>Reload the paper correctly and press [OK].</p> <p> Note</p> <p>Pressing [Stop/Reset] also enables you to resolve the error, when sending faxes before printing out received data. After you press [Stop/Reset] to resolve the error, ensure to press [FAX] in order to print out data remained in memory.</p>
MEMORY IS FULL	<p>The machine's memory is full because you tried to copy too many pages at once or a very detailed document.</p> <p>Divide the document and copy each part separately.</p> <p>The machine's memory is full because it has received too many documents, or a very long or detailed document.</p> <p>Contact the sender and have him/her divide and resend them.</p>
PAPER JAMMED	<p>If paper has jammed in the machine, clear the jam, reload the paper in the machine correctly and then press [OK].</p>
PRESS [BLACK]	<p>[Color] is pressed.</p> <p>Press [Black].</p>
PRESS [COLOR]	<p>[Black] is pressed.</p> <p>Press [Color].</p>
SCANNER ERROR	<p>Contact the Canon Customer Care Center.</p>
WASTE INK NEAR FULL	<p>Ink used for cleaning is absorbed in a waste ink absorber placed in the machine.</p> <p>Press the [OK] to cancel the error so that you can continue printing. Once the waste ink absorber becomes completely full, printing cannot be done until the waste ink absorber is replaced.</p> <p>Canon recommends to contact a Canon Customer Care Center as soon as possible.</p> <p>You will need to replace a particular part of the machine.</p>

Note

Adjusting the Print Head Manually

If the Automatic Print Head Alignment does not work or if you wish to adjust the print heads manually, follow the procedure below.

1. Press [ON/OFF] to turn on the machine, and then load two sheets of A4/Letter-sized plain paper in the Auto Sheet Feeder or Cassette.
2. Ensure that the proper paper source is selected.
3. Press [Menu] repeatedly to display the Maintenance screen.
4. Use [◀] or [▶] to select <ALIGN PRINT HEAD>, then press [OK].
The Print Head alignment pattern is printed.
5. Check the printed patterns and use [◀] or [▶] to input the number of the pattern in column A that has the least noticeable streaks.



6. Press [OK] to move the cursor to column B, and then use [◀] or [▶] to input the number of the pattern that has the least noticeable streaks.
7. Repeat the procedure until you finish inputting the pattern number for column P.
8. When you have finished inputting all pattern numbers, press [OK].



■ Fax Related Messages

Message	Action
BUSY/NO SIGNAL	<p>The telephone number you dialed is busy. Try dialing again after waiting for a moment. See “Redialing a Busy Number” on page 76.</p> <p>The fax number dialed was incorrect. Check the fax number and dial again.</p> <p>The recipient’s fax machine is not working. Contact the recipient and have them check their fax machine.</p> <p>The recipient is not using a G3 machine. Contact the recipient and ask them to send or receive the document using a G3 machine.</p> <p>The touch tone/rotary pulse setting on your machine is incorrect. Set your machine to the setting that matches your telephone line. See “Setting the Telephone Line Type” on page 62.</p> <p>The receiving fax machine did not answer within 55 seconds (after all automatic redialing attempts). Contact the recipient and have them check their fax machine. For an overseas call, add pauses to the registered number.</p>
HANG UP PHONE	<p>The handset is not placed in the handset cradle correctly. Replace the handset correctly.</p>
NO ANSWER	<p>The recipient’s fax machine does not answer. Check the number. Try dialing again after waiting for a moment.</p>
NO TONE DETECTED	<p>The telephone line cable with a modular plug is not plugged in properly, or <DIAL TONE DETECT> is set to <ON>. Make sure that the cable is plugged in properly, and resend the fax after a while. If you still cannot send the fax, set <DIAL TONE DETECT> to <OFF>.</p>
NO RX PAPER	<p>The other party’s fax machine is out of paper or its memory is full. Contact the other party and have them load paper in their fax machine or free up space in their fax machine’s memory.</p>
NO TEL NUMBER	<p>The coded speed dialing code you entered has not been registered. Register the coded speed dialing code.</p>
RECEIVED IN MEMORY	<p>The machine was not able to print the received fax either because the paper size setting is incorrect or the ink has run out, and the fax is stored in memory. Correct the paper size setting or replace the ink tank. See “Replacing an Ink Tank” on page 98.</p>
TRY AGAIN IN B&W	<p>The recipient’s fax machine is not color-compatible. Press [Black] to resend the faxes.</p>
TX/RX CANCELLED	<p>You pressed [Stop/Reset] to cancel the transmission. If required, try sending or receiving again.</p>
TX/RX NO.nnnn	<p>When the machine sends or receives a fax, it assigns a unique identification number (nnnn). Write the number down if you will need it later.</p>

Cannot See the Display on the LCD

Cause	Action
Cannot see the display on the LCD.	<p>The machine is not powered on. The machine will power ON and the LCD will display a message when you connect the power cord and press [ON/OFF].</p>

Ink Does Not Come Out/Printing is Blurred/Colors are Wrong/White Streaks/Straight Lines are Misaligned/ Cannot Print to End of Job

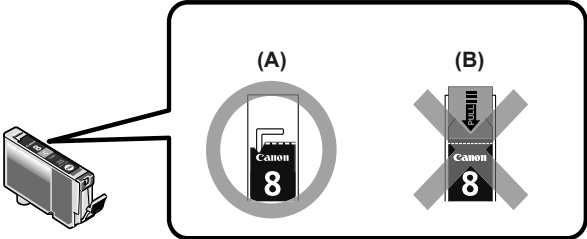
Cause	Action
Ink tank is empty.	<p>If the ink lamp is flashing, ink is empty. Replace the ink tank, and close the Scanning Unit (Printer Cover). If printing is not finished yet, just press the [OK] on the machine to continue printing in the "no ink" state. Replace the ink tank with a new one as soon as possible after printing has finished. The machine may be damaged if printing is continued under the ink out condition.</p> <p> Note If multiple ink lamps are flashing, check how fast they flash. Fast flashing (about one second) indicates the ink is empty. Slow flashing (about three seconds) indicates ink is low. For details on different flashing speeds, see "Getting the Ink Level Information" on page 98.</p>
Ink tank is not fully inserted.	<p>When the ink lamp is unlit, press the  mark on the ink tank clicks into place. The ink lamp lights red when the ink tank is fully inserted. Make sure all of the orange tape is peeled off the ink tank as illustrated in (A). If any orange parts are left like in (B), remove all of the orange parts.</p> <div data-bbox="415 938 1002 1177">  </div> <p>(A) Correct An L shaped notch appears on the ink tank.</p> <p>(B) Incorrect There remains the orange tape. Peel off the tape completely along the perforation.</p> <p>If ink tank is empty, replace the ink tank.</p>

Cause	Action
Incorrect media type	<p>When printing directly from a digital camera, on the operation panel, confirm that the <TYPE> selected matches the paper loaded.</p> <p>When printing from a computer, check the following.</p> <p>Windows</p> <p>On the [Main] tab of the printer driver, ensure that the [Media Type] selected matches the paper loaded.</p> <p>Macintosh</p> <p>In the [Print] dialog box of the printer driver, select [Quality & Media] from the pop-up menu, and then ensure that the [Media Type] selected matches the paper loaded.</p>
Print Head nozzles clogged or shifted	<p>Open the Scanning Unit (Printer Cover) and check if all ink lamps light red. Print the nozzle check pattern to check for uneven ink output. See “Printing the Nozzle Check Pattern” on page 104.</p> <ul style="list-style-type: none"> ● Ink supply is uneven. <ul style="list-style-type: none"> See “Print Head Cleaning” on page 105. See “Print Head Deep Cleaning” on page 106. ● If straight lines are shifted. <ul style="list-style-type: none"> See “Aligning the Print Head Automatically” on page 106.
Print quality is not set properly.	<p>Be sure to set the [Print Quality] setting to [High] in Windows, or [Fine] in Macintosh.</p> <p>Windows</p> <ol style="list-style-type: none"> 1. Open the printer properties dialog box. 2. On the [Main] tab, click [High] for the [Print Quality] setting. <p>When you cannot choose the [High] setting or when the print quality does not improve, select [Custom], click [Set] and then adjust the Quality bar for higher print quality.</p> <p>Macintosh</p> <ol style="list-style-type: none"> 1. Open the [Print] dialog box. 2. Select [Quality & Media] from the pop-up menu and then click [Detailed Setting]. 3. Drag the [Print Quality] slide bar to the [Fine] end.
The media is loaded with the wrong side face upwards.	Load the media with the correct side face upwards.
The paper stack exceeds the capacity of the Auto Sheet Feeder or Cassette.	If the paper stack exceeds the paper limit mark, or exceeds the capacity of the Auto Sheet Feeder or Cassette, reduce the amount of paper. See “Recommended Paper and Requirements” on page 22.
There is some foreign matter in the Auto Sheet Feeder or Cassette.	Check and remove any foreign matter.
The paper source is not configured properly.	Make sure that the paper source in which the paper is loaded is correctly configured. See “Changing the Paper Source” on page 26.
The Paper Output Tray is closed.	Press the Open Button to open the Paper Output Tray.
Inner Cover is open.	Close Inner Cover then press [OK] on the machine.

Cause	Action
<p>Unnecessary print jobs are queued./ Computer problems</p>	<p>Restart your computer. It may solve the problem.</p> <p>Delete an undesired print job, if there is any. Use Canon IJ Status Monitor in Windows or Printer Setup Utility (or Print Center) in Macintosh for the deletion.</p> <p>Windows</p> <ol style="list-style-type: none"> 1. Open the printer properties dialog box. 2. Click the [Maintenance] tab and then [View Printer Status]. 3. Click [Display Print Queue]. 4. Select [Cancel All Documents] in the [Printer] menu. <p>Note</p> <p>In Windows Me or Windows 98 Select [Purge Print Documents] in the [Printer] menu.</p> <p>In Windows XP or Windows 2000 [Cancel All Documents] may not be selected.</p> <ol style="list-style-type: none"> 5. When the confirmation message is displayed, click [Yes]. The print job is deleted. <p>Macintosh</p> <ol style="list-style-type: none"> 1. Click the printer's icon in the Dock and display the list of print jobs in progress. When using Mac OS X v.10.2, click the printer icon in the Dock to start [Print Center] and then double-click the name of your machine under [Printer List] to display the list of print jobs. 2. Click to select an undesired document and click . The print job is deleted.
<p>The machine has been printing continuously over a long period.</p>	<p>If so, the Print Head will overheat. To protect the Print Head, printing will stop temporarily and resume after a period of time. Interrupt printing when appropriate, turn OFF the machine, and wait at least 15 minutes.</p> <p>Caution</p> <p>The area around the Print Head may become extremely hot. Do not under any circumstances touch it.</p>
<p>You are printing high-resolution documents such as photographs or illustrations.</p>	<p>If you are printing high-resolution documents, processing the data will take time, and printing will appear to have stopped depending on your computer or environment. Wait until data is processed. If you are printing a document with a large printing area (with small margins) or are printing multiple sets, printing may stop to allow the ink time to dry.</p>
<p>Incorrect page size is selected.</p>	<p>Ensure that the page size setting matches the size of the paper loaded in the machine:</p> <ul style="list-style-type: none"> ● Check the page size setting from within your application to ensure that it matches the size of the paper loaded. ● Check [Page Size] on the [Page Setup] tab in the printer properties dialog box of the printer driver (Windows) or the [Page Setup] dialog box of the printer driver (Macintosh) to ensure that it matches the size of the paper loaded.

Cause	Action
<p>Windows</p> <p>The size of the print data is too large.</p>	<p>Check the size of the print data. For Windows XP and Windows 2000, if the size of the data is too large, part of it may be lost. When the spool format is EMF, follow the procedure below.</p> <ol style="list-style-type: none"> 1. Open the printer properties dialog box. 2. On the [Page Setup] tab, click [Print Options]. 3. Select the [Reduce spool data size] check box, and click [OK]. <p>Note</p> <ul style="list-style-type: none"> ● When [Reduce spool data size] is set, the print quality may be degraded. ● This is useful when a part of straight lines or data is lost for page layout printing.
<p>Performing automatic duplex printing</p>	<p>Select [Use reduced printing] in the printer driver. It may solve the problem.</p> <p>Windows</p> <ol style="list-style-type: none"> 1. Open the printer properties dialog box. 2. Click [Print Area Setup] in the [Page Setup] tab and select [Use reduced printing]. <p>Macintosh</p> <ol style="list-style-type: none"> 1. In the [Print] dialog box, select [Duplex Printing & Margin] from the pop-up menu. 2. Select [Automatic Duplex Printing], and select [Use reduced printing] in Print Area.

■ When Copying

Cause	Action
<p>The document is not loaded correctly.</p>	<p>Check that the document is loaded correctly on the Platen Glass or in the ADF.</p> <p>See "Loading Documents" on page 19.</p>
<p>The quality (Print quality) displayed on the LCD is not suitable for the document.</p>	<p>Set the image quality suitable for the document.</p> <p>See "Copying" on page 40.</p>
<p>The document is not loaded with the side to be copied face down.</p>	<p>When loading the document on the Platen Glass, the side to be copied should be face down.</p> <p>When loading in the ADF, the side to be copied should be face up.</p>
<p>The document or photograph set on the Platen Glass or in the ADF was printed from your machine.</p>	<p>Image quality may be poor if you copy a printed document or photograph. Instead, reprint the photograph directly from the digital camera, or the document from your computer.</p>
<p>The Platen Glass or inner side of the Document Cover is dirty.</p>	<p>Clean the Platen Glass or inner side of the Document Cover, or the ADF.</p> <p>See "Cleaning the Platen Glass and Document Cover" on page 107.</p>

Back of Paper is Smudged/Paper Does Not Feed Properly/Printed Surface is Scratched

Cause

Inside of the machine is dirty.

Action

If the inside of the machine is dirty, printed paper may be smudged. Follow the steps described below to clean the inside of the machine.

1. Press [ON/OFF] to turn on the machine, then remove any paper from the Auto Sheet Feeder.

See "Turning on the Machine" on page 18.

2. Press the Open Button to open the Paper Output Tray, and open up and set the extension by pressing down the hollow on the front side.

3. Place the only one sheet of A4/Letter-size plain paper in landscape, horizontally fold it in half.

4. Unfold the paper, and load the paper in the Auto Sheet Feeder with the inverted-V edge down.

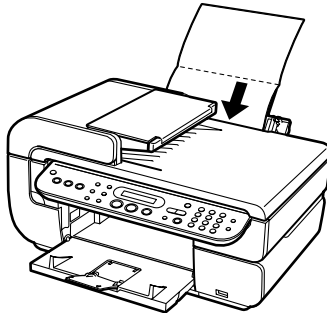

5. Use [◀] or [▶] to select <BOTTOM CLEANING> from the <MAINTENANCE> and press [OK].

The paper that is loaded in the machine will feed through the machine and be ejected.

If protrusions inside the machine are stained, wipe ink off the protrusions using a swab or the like.

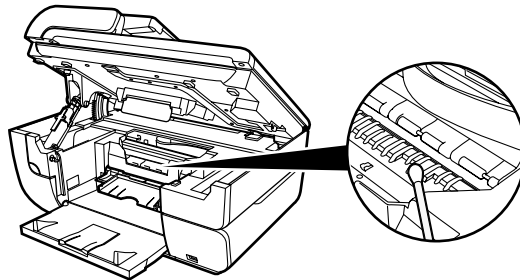

Important

Before cleaning, be sure to turn off the machine.

Cause	Action
Paper Feed Roller is dirty.	<p>Follow the steps described below to clean the Paper Feed Rollers. Cleaning the Paper Feed Rollers consumes them, so perform this procedure only when necessary.</p> <ol style="list-style-type: none"> 1. Press [ON/OFF] to turn on the machine, then remove any paper from the Auto Sheet Feeder and Cassette. See “Turning on the Machine” on page 18. 2. Use [Feed Switch] to select the paper source to clean. 3. Use [◀] or [▶] to select <ROLLER CLEANING> from the <MAINTENANCE> and press [OK]. The Paper Feed Roller will rotate as it cleans. 4. Repeat steps 3, two times. 5. Press the Open Button to open the Paper Output Tray, and then open up and set the Paper Output Tray Extension completely by pressing down the hollow on the front side. 6. Load three or more sheets of A4/Letter-sized plain paper lengthways in the paper source you selected in step 2. 7. Repeat steps 3, three times. The paper that is loaded in the machine will feed through the machine and be ejected. <p>If there are no signs of improvement after performing three times, contact the Canon Customer Care Center.</p>
Inappropriate media type is used.	<ul style="list-style-type: none"> ● Check to see if the paper you are printing on is too thick or curled. See “Media Types You cannot Use” on page 23. ● Note that smudging may occur at the top and bottom edges of the paper when using Borderless Printing. Ensure that the paper you are using is compatible with Borderless Printing. Refer to the <i>Printer Driver Guide</i>.

Cause	Action
<p>Thick paper is used.</p>	<p>If you set the machine to prevent paper abrasion, the clearance between the Print Head and the loaded paper is widened.</p> <p>If the printing surface is abraded even with the media type set correctly to match the loaded paper, set the machine to prevent paper abrasion.</p> <p>When copying or printing directly, see "If printing surface abrasion is not resolved even after taking the actions above:" on page 126.</p> <p>When printing from a computer, follow the procedure below.</p> <p>Windows</p> <ol style="list-style-type: none"> 1. Open the printer properties dialog box. 2. Click the [Maintenance] tab and then [Custom Settings]. <p>Important</p> <p>In Windows XP or Windows 2000</p> <p>When not logged on as a computer administrator or Administrators, you cannot open the [Custom Settings] dialog box.</p> <p>For further information on how to log on as an administrator, refer to your Windows documentation.</p> <ol style="list-style-type: none"> 3. Select the [Prevent paper abrasion] check box and click [Send]. 4. Click [OK] when the confirmation message appears. <p>Macintosh</p> <ol style="list-style-type: none"> 1. Open the [Canon IJ Printer Utility] dialog box. 2. Select [Custom Settings] from the pop-up menu. 3. Select [Prevent paper abrasion]. <p>Note</p> <p>Clear the [Prevent paper abrasion] check box once printing is complete. When [Prevent paper abrasion] is selected in the printer properties dialog box (Windows) or selected from [Custom Settings] in the Canon IJ Printer Utility dialog box (Macintosh), the setting is also applied under direct printing with the digital camera.</p>
<p>Paper is curled.</p>	<p>If all four corners or the printing surface of the paper is curled, the paper may become dirty or the paper may not feed properly. Use the paper after correcting paper curl as follows.</p> <ol style="list-style-type: none"> 1. Face up the printing surface (A), and cover it with a non-printing regular paper to avoid staining or scratching the surface. 2. Roll up the paper in a direction opposite to paper curl as the figure below. <ol style="list-style-type: none"> 3. Check the printing paper if paper is corrected within approximately 2 to 5 mm / 0.08" to 0.2" in (B). <p>It is recommended to print the curl-corrected paper one sheet at a time.</p>

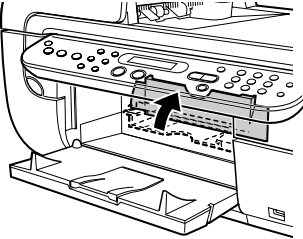
Cause	Action
<p>Inner Cover is not closed completely.</p>	<p>Close the Inner Cover completely. Paper does not feed properly if the Inner Cover is even slightly open.</p> 
<p>The media type is not selected correctly in the printer driver.</p>	<p>Windows</p> <p>On the [Main] tab of the printer driver, ensure that the [Media Type] selected matches the paper loaded. The print surface is smudged with some printing jobs despite being set correctly. Should this occur, on the [Maintenance] tab, click [Custom Settings] and place a check in [Prevent paper abrasion].</p> <p>Macintosh</p> <p>In the [Print] dialog box of the printer driver, select [Quality & Media] from the pop-up menu, and then ensure that the [Media Type] selected matches the paper loaded. Additionally, the print surface may become smudged with some printing jobs despite being set correctly. Should this occur, click on [Custom Settings] from the Canon IJ Printer Utility pop-up menu and place a check in [Prevent paper abrasion].</p>
<p>Paper is loaded incorrectly.</p>	<p>Load in the portrait orientation regardless of the print direction of the Auto Sheet Feeder or Cassette.</p> <p>Ensure that paper is loaded correctly. Slide the Paper Guides against the paper stack.</p>
<p>The paper stack exceeds the capacity of the Auto Sheet Feeder.</p>	<p>The paper cannot be fed normally depending on its media type or your environment where the temperature and humidity are high or low. In that case, reduce the amount of paper to half (approx. 5 mm / 0.2" in height).</p>

Note

If printing surface abrasion is not resolved even after taking the actions above:

Follow the procedure below to specify <PREVENT ABRASION> to <ON>.

The procedure below can also be used when printing directly from a digital camera.

1. Display <DEVICE SETTINGS>. See “Changing the Settings” on page 91.
2. Use [◀] or [▶] to select <PRINT SETTINGS>, then press [OK].
3. Use [◀] or [▶] to select <PREVENT ABRASION>, then press [OK].
4. Use [◀] or [▶] to select <ON>, then press [OK].

After finishing printing, use the same procedure to specify <PREVENT ABRASION> back to <OFF>.

■ Paper Curls/Ink Blots

Cause	Action
<p>Paper being used is too thin.</p>	<p>Use Photo Paper Pro or other Canon specialty paper to print images that have a high color saturation. See “Media Types You cannot Use” on page 23.</p>

Cause	Action
The media type is not selected correctly on the Operation Panel.	Ensure that the media type selected on the operation panel matches that of the paper loaded.

Paper Jams

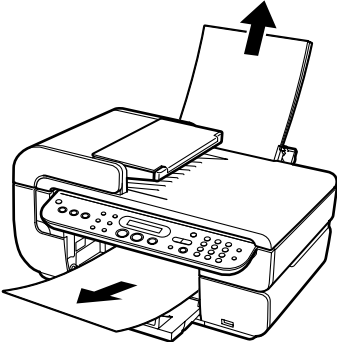
Cause	Action
Paper jams in the Paper Output Slot/Auto Sheet Feeder.	<p>Remove the paper according to the following procedure.</p> <ol style="list-style-type: none"> 1. Slowly pull the paper out, either from the Auto Sheet Feeder or from the Paper Output Slot, whichever is easier.  <ul style="list-style-type: none"> ● If the paper tears and a piece remains inside the machine, open the Scanning Unit (Printer Cover) and remove it. Be careful not to touch the components inside the machine at this time. After removing all paper, close the Scanning Unit (Printer Cover), turn the machine off and turn it back on. ● If you cannot pull the paper out, turn the machine off and turn it back on. The paper will be ejected automatically. <ol style="list-style-type: none"> 2. Reload the paper into the machine and press [OK]. <ul style="list-style-type: none"> ● If you have turned off and on the machine in step 1, you will need to retry printing, because this operation cancels any print jobs in progress. <p>If you cannot remove the paper or the paper tears inside the machine, or if the paper jam error continues after removing the paper, contact the Canon Customer Care Center.</p>

Cause

Paper jams inside the machine (Transport Unit).

Action

Remove the paper according to the following procedure.

1. Open the Rear Cover.

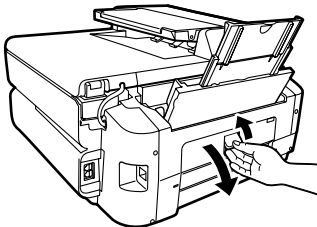

2. When you can see the jammed paper, slowly pull the paper out.

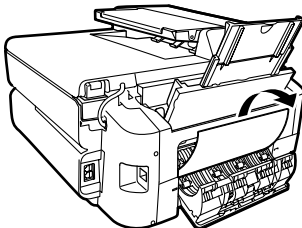

Be careful not to touch the components inside the machine.

If you cannot pull the paper out, turn the machine off and turn it back on. The paper will be ejected automatically.

3. Close the Rear Cover.

4. If you could not extract the paper in step 2, remove the Cassette.

5. Slowly pull the jammed paper out.

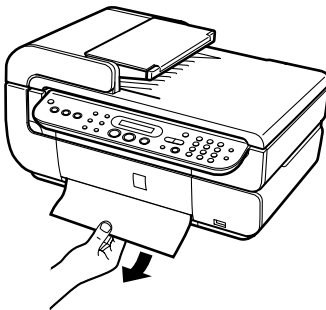

6. If any paper is sticking out of the Cassette, reload the paper in the Cassette.

7. Insert the Cassette into the machine again, and press the [OK] on the machine.

If you have turned off and on the machine in step 2, you will need to retry printing, because this operation cancels any print jobs in progress.

If you cannot remove the paper or if the paper tears inside the machine, or if the paper jam error continues after removing the paper, contact the Canon Customer Care Center.

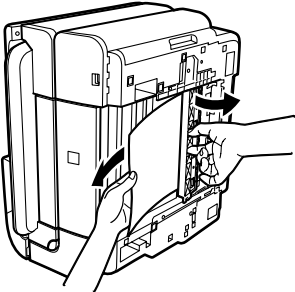
Cause	Action
<p>Paper jams inside the machine (Duplex Transport Section).</p>	<p>Remove the paper according to the following procedure.</p> <ol style="list-style-type: none"> 1. Remove the Cassette. <ul style="list-style-type: none"> If the paper is loaded in the Auto Sheet Feeder, remove the paper from the Auto Sheet Feeder. 2. Stand the machine with the left side down. <p>⚠ Caution Always stand the machine with the left side down when standing the machine. Be careful that the right side is not down.</p> <ol style="list-style-type: none"> 3. Slowly pull the jammed paper out while pulling the green cover toward you.  <p>⚠ Caution Put back the machine immediately after removing the jammed paper.</p> <ol style="list-style-type: none"> 4. If any paper is sticking out of the Cassette, reload the paper in the Cassette. <ul style="list-style-type: none"> Reload paper in the Auto Sheet Feeder, if necessary. 5. Insert the Cassette into the machine. 6. Press the [OK] on the machine. <p>If you cannot remove the paper or if the paper tears inside the machine, or if the paper jam error continues after removing the paper, contact the Canon Customer Care Center.</p>
<p>Landscape Credit Card-sized paper jams inside the machine.</p>	<p>You cannot load Credit Card-sized paper in the landscape orientation. Remove the paper according to the following procedure.</p> <ol style="list-style-type: none"> 1. Load Credit Card-sized paper in the Auto Sheet Feeder one sheet at a time. <ul style="list-style-type: none"> Do not load it in the landscape orientation. 2. Press the [ON/OFF] on the machine to turn off the power. 3. Press the [ON/OFF] again on the machine to turn on the power. <ul style="list-style-type: none"> The paper is fed and the jammed paper is ejected accordingly. <p>If you cannot remove the jammed paper or the error still persists, contact the Canon Customer Care Center.</p>

Cause	Action
<p>Landscape 101.6 x 152.4 mm / 4" x 6" media loaded in the Cassette jams inside the machine.</p>	<p>Load 101.6 x 152.4 mm / 4" x 6" media in the portrait orientation regardless of the print direction.</p> <p>Remove the paper according to the following procedure.</p> <ol style="list-style-type: none"> 1. Press [ON/OFF] of the machine to turn off the power. Open the Rear Cover. 2. Fold a piece of plain A4- or Letter-sized paper in four, push it in until it hits the jammed paper, then pull out the paper folded in four. 3. Close the Rear Cover, then press [ON/OFF] of the machine to turn on the power. Wait until the jammed paper is automatically ejected. <p>If you cannot remove the jammed paper or the error still persists, contact the Canon Customer Care Center.</p>

Document Jams

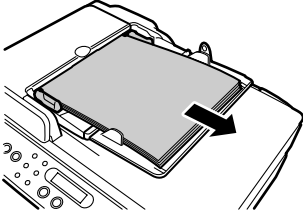
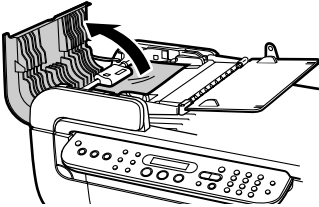
Cause	Action
<p>Document jams in the ADF (Document Tray).</p>	<p>Remove the document according to the following procedure.</p> <ol style="list-style-type: none"> 1. Press [Stop/Reset]. 2. If a multi-page document is loaded, remove any pages other than the jammed page from the ADF.  <p>3. Open the Feeder Cover.</p> 

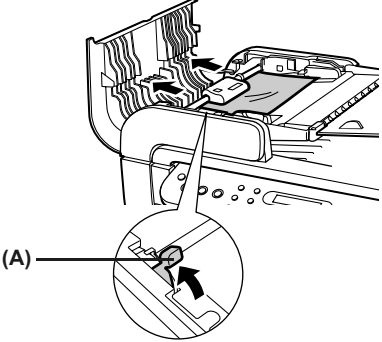
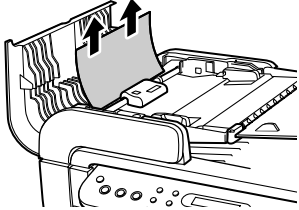
Cause	Action
<p>Document jams in the ADF (Document Tray).</p>	<p>4. Raise the paper release lever (A) then remove the jammed page from under the roller to the Feeder Cover side.</p>  <p>5. Pull out the jammed document from the ADF. If the document cannot be pulled out with ease, follow the procedure from step 2 under "Document jams in the ADF (inner side)." on page 132.</p> 

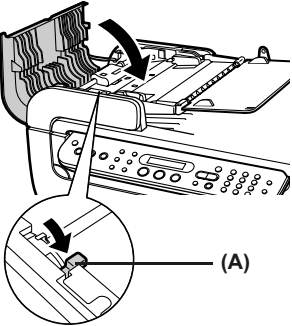
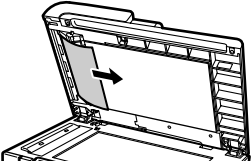
Cause	Action
	<p>6. Lower the paper release lever (A) then close the Feeder Cover.</p> <ul style="list-style-type: none"> ● If documents remain in the ADF after pressing [Stop/Reset] during scanning, press [OK]. The remaining document is automatically fed out. ● When rescanning the document after clearing the error, rescan it from the first page. <p>If you cannot remove the document or the document tears inside the machine, or if the document jam error continues after removing the document, contact the Canon Customer Care Center.</p>  <p>Note</p> <p>The document may not feed properly depending on the media type, or your environment, such as when the temperature and humidity are either too high or too low.</p> <p>In this case, reduce the number of document pages to approximately half of the loading capacity. See “Document Requirements” on page 19.</p> <p>If the document still jams, use the Platen Glass instead.</p>
<p>Document jams in the ADF (inner side).</p>	<p>Remove the document according to the following procedure.</p> <ol style="list-style-type: none"> 1. Follow steps 1 to 3 under “Document jams in the ADF (Document Tray)” on page 130. 2. Open the Document Cover and pull out the document from the inner side.  <ol style="list-style-type: none"> 3. Close the Document Cover. 4. Lower the paper release lever then close the Feeder Cover. <ul style="list-style-type: none"> ● When rescanning the document after clearing the error, rescan it from the first page. <p>If you cannot remove the document or the document tears inside the machine, or if the document jam error continues after removing the document, contact the Canon Customer Care Center.</p>

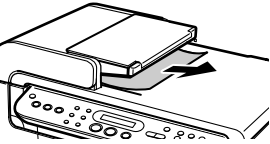
Cause	Action
<p>Document Jams in the ADF (Document Output Slot).</p>	<p>If the document is jammed in the Document Output Slot, pull it out.</p>  <ul style="list-style-type: none"> ● When rescanning the document after clearing the error, rescan it from the first page. <p>If you cannot remove the document or the document tears inside the machine, or if the document jam error continues after removing the document, contact the Canon Customer Care Center.</p>

Cannot Print Properly from the Digital Camera

The following are the possible errors that may occur when printing directly from a digital still camera or digital video camcorder*, and the countermeasures to eliminate them.

* Hereafter, the digital still camera and digital video camcorder are collectively called a digital camera or camera.

Note

- PictBridge or Canon Bubble Jet Direct compatible digital cameras can be connected to your machine for direct printing.
- This section describes errors that are indicated on Canon-brand PictBridge- or Bubble Jet Direct compatible cameras. The error messages and operations may vary depending on the camera you are using. If you are using a non-Canon PictBridge compatible camera and not sure how to clear the printer error from the camera, confirm the message displayed on the LCD of the machine and clear the error. For clearing an error from the machine, see “An Error Message is Displayed on the LCD” on page 113.
- A communication time out occurs if printing takes a long time or if it takes too much time to send data. This may stop printing. In such cases, disconnect the cable between the machine and the camera, and reconnect the cable between the machine and the camera. Then, turn the camera on, if it does not automatically turn on. If the problem is still unresolved, select some other photo and check if it can be printed or not.
- Some PictBridge compatible devices may need to be switched to printing mode before connecting them to the machine, depending on the model of the camera. Also, it may need to be turned on manually or switched to replay mode after connected to the machine. Refer to the instruction manuals supplied with your PictBridge compatible device and take the necessary steps before connection.
- The print head nozzles may be clogged if printing becomes faint or colors are incorrect. See “When Printing Becomes Faint or Colors are Incorrect” on page 103.
- If the paper is curled or its surface is scratched during printing, make sure that you are using the correct type of paper. If this error occurs even when you are using the correct type of paper, see “If printing surface abrasion is not resolved even after taking the actions above:” on page 126.
- For the errors indicated on the camera and their solution, also refer to the user’s manual of the camera. For other troubles with a digital camera, contact the manufacturer of the camera.

Error Message On Camera	Action
<p>Printer in use/Printer warming up</p>	<p>Photos are printed from the computer. Wait until printing ends. When it is ready, the machine starts printing automatically.</p>

Error Message On Camera	Action
No paper/Paper Error	<ul style="list-style-type: none"> ● Load paper in either the Auto Sheet Feeder or Cassette which you have selected with the [Feed Switch] on the machine, and select "Continue" in the display on your camera. ● The camera does not support the page size that is selected on this machine. Check the print settings and select the page size that is supported by the camera. ● Open the Paper Output Tray to resume printing. Close the Inner Cover if it is open. Select "Stop" in the display on your camera to stop printing.
Paper jam	<p>Select "Stop" in the display on your camera to stop printing.</p> <p>Remove the jammed paper, load new paper, and press the [OK] on the machine and retry printing.</p>
Printer cover open	<p>Close the Scanning Unit (Printer Cover) on the machine.</p>
No print head	<p>The Print Head is defective or not installed.</p> <p>Install a Print Head according to the <i>Easy Setup Instructions</i>.</p> <p>If the Print Head has already been installed, remove the Print Head and reinstall it.</p> <p>If the error still remains, the Print Head may be defective. Contact the Canon Customer Care Center.</p>
Waste tank (ink absorber) full	<p>This error message indicates that the waste ink absorber is nearly full.</p> <p>The machine has a built-in waste ink absorber to hold the ink used during Print Head cleaning, for example. You can continue printing by selecting "Continue" on the display on your camera.</p> <p>However, because printing is disabled once the waste ink absorber becomes completely full and until the waste ink absorber is replaced, you are recommended to contact the Canon Customer Care Center as early as possible. You will need to replace a particular part of the machine.</p>
Low ink level	<p>Slow flashing (about three seconds in red) of an ink lamp indicates that ink in this tank is low. Prepare a new ink tank.</p> <p>Select "Continue" in the display on your camera to resume printing.</p>

Error Message On Camera	Action
No Ink	<p>You can check the machine status according to the way the ink lamps (red) flash.</p> <p>Check the status of each lamp and take the appropriate action to clear the error. See “Getting the Ink Level Information” on page 98.</p> <p>When the ink lamp is off:</p> <ul style="list-style-type: none"> ● The ink tank may not be installed properly. Install the appropriate ink tank. ● The ink tank may not be compatible with this machine. Install the appropriate ink tank. See “Replacing an Ink Tank” on page 98. <p>When the ink lamp flashes fast (about one second):</p> <ul style="list-style-type: none"> ● The ink has run out. Replace the ink tank, and close the Scanning Unit (Printer Cover). If printing is in progress and you want to continue printing, select "Continue" in the display on your camera with the ink tank installed. Then printing can continue under the ink out condition. Replace the empty ink tank immediately after the printing. The machine may be damaged if printing is continued under the ink out condition. <p> Note</p> <p>If multiple ink lamps are flashing, check how fast they flash. Fast flashing (about one second) indicates the ink is empty. Slow flashing (about three seconds) indicates ink is low. For details on different flashing speeds, see “Knowing When to Replace Ink Tank” on page 99.</p> <ul style="list-style-type: none"> ● Some ink tanks are not installed in place, or more than one ink tanks of the same color are installed. Confirm that the ink tanks are installed in the appropriate positions. See “Replacing Ink Tanks” on page 99.
Ink error/No ink	<p>The ink tank that was once empty is installed. Replace the ink tank.</p> <p>Printing under the situation may damage the Print Head. Canon shall not be liable for any machine malfunction or damage caused by refilled ink tanks.</p> <p>If you want to continue printing with the refilled ink tank installed, press and hold [Stop/Reset] for at least 5 seconds, and then release it.</p> <p>Using refilled ink tanks are memorized.</p> <p>* This operation will release the function for detecting the remaining ink level.</p>
Hardware Error/No ink	<p>Ink tank errors have occurred. Replace the ink tank.</p> <p>See “Replacing an Ink Tank” on page 98.</p>
Printer error	<p>An error requiring servicing might have occurred.</p> <p>Disconnect the cable between the machine and the camera, turn off the machine and unplug the power cord of the machine from the power supply. After a while, plug the power cord of the machine back in, turn on the machine, and then reconnect the camera to the machine. If the same error occurs, contact the Canon Customer Care Center.</p>

* To resume printing, you can press [OK] on the machine instead of selecting Continue.

Cannot Install the MP Drivers

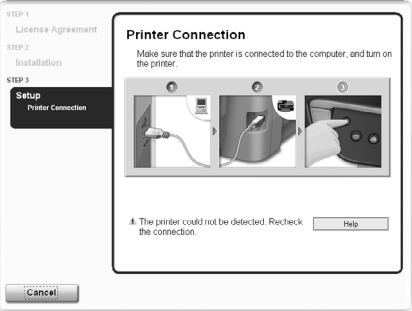
Cause	Action
<p>Windows</p> <p>Unable to proceed beyond the Printer Connection screen</p>	<p>Reinstall the MP Drivers.</p>  <ol style="list-style-type: none"> 1. Click [Cancel] on the [Printer Connection] screen. 2. Click [Start Over] on the [Installation Failure] screen. 3. Click [Back] on the screen that appears next. 4. Click [Exit] on the [Welcome] screen, then remove the CD-ROM. 5. Turn the machine and the computer off. 6. Check the cable connection. 7. Restart the computer. 8. Make sure that no other applications (including anti-virus software) are running in the background. 9. Carefully follow the procedures described in the <i>Easy Setup Instructions</i> and reinstall the MP Drivers.
<p>Installation does not start automatically when the Setup CD-ROM is inserted into the drive.</p>	<p>Windows</p> <p>Click [Start], select [My Computer] and then double-click the CD-ROM icon.</p> <p>For non-Windows XP users, open the [My Computer] window and then double-click the CD-ROM icon.</p> <p>Macintosh</p> <p>Double-click the CD-ROM icon on your desktop to start installation.</p> <p>If the CD-ROM icon is not displayed on the desktop, there is a problem with the CD-ROM.</p> <p>Contact the Canon Customer Care Center.</p>
<p>You have a defective Setup CD-ROM.</p>	<p>If you have a defective Setup CD-ROM, please contact the Canon Customer Care Center.</p> <p>Windows</p> <p>Select [My Computer] from the [Start] menu and check if the CD-ROM icon is displayed.</p> <p>Macintosh</p> <p>Reconfirm that the CD-ROM icon is displayed when you insert the CD-ROM.</p>
<p>Windows</p> <p>The computer has an old version of the software installed (Canon MultiPASS is registered as a program in the [Start] menu).</p>	<p>Uninstall the old version of the software following the instructions in the manual of that version, and reinstall the new version.</p>

Cause	Action
Installation procedure not followed correctly	<p>Follow the <i>Easy Setup Instructions</i> packaged with your machine for proper MP Drivers installation.</p> <p>If the MP Drivers was not installed correctly, uninstall the MP Drivers, and restart your computer. Try to reinstall the MP Drivers.</p> <p> If the installer was forced to be terminated due to an error, restart your computer.</p> <p>Reinstall the MP Drivers.</p>

Cannot Connect to Computer Properly

■ Printing Speed is Slow/USB 2.0 Hi-Speed Connection Does Not Work

Cause	Action
Your environment is not fully compatible with USB 2.0 Hi-Speed.	<p>If your environment is not fully compatible with USB 2.0 Hi-Speed, the printer will operate at a lower speed provided under USB 1.1. In this case, the machine operates properly but printing speed may slow down due to communication speed.</p> <p>Check the following to ensure that your computer environment supports USB 2.0 Hi-Speed connection.</p> <ul style="list-style-type: none"> ● The USB port on your computer supports USB 2.0 Hi-Speed connection. ● Both the USB cable and USB hub support USB 2.0 Hi-Speed connection. <p>Be sure to use a certified USB 2.0 Hi-Speed cable. You are recommended to use the cable no longer than 3 meters (9.8 feet).</p> <ul style="list-style-type: none"> ● Your computer supports the USB 2.0 Hi-Speed connection. <p>Obtain the latest version of the USB 2.0 Hi-Speed driver and install it on your computer.</p> <ul style="list-style-type: none"> ● The USB 2.0 Hi-Speed driver operates properly. <p>Obtain the latest version of the USB 2.0 Hi-Speed driver and install it on your computer.</p> <p> Important</p> <p>For how to confirm the points above, contact the manufacturer of your computer, USB cable, or USB hub, as appropriate.</p>



■ When You Connect to a Computer Running Windows XP, the Screen Shows the Warning Message “This device can perform faster” or “High-SPEED USB Device Plugged into non-High-SPEED USB Hub”

Cause	Action
You connect to a computer that does not support USB 2.0 Hi-Speed.	Your environment is not fully compatible with USB 2.0. See “Printing Speed is Slow/USB 2.0 Hi-Speed Connection Does Not Work” on page 137.

Problems Receiving Faxes

■ Cannot Receive a Fax/Cannot Print a Fax

Cause	Action
The machine is not on.	<ul style="list-style-type: none"> ● You cannot receive faxes if the power is turned off. Press [ON/OFF] to turn the power on. See "Turning the Machine ON and OFF" on page 18. ● After a power failure or disconnecting of the power cord, press [ON/OFF] to turn the power ON.
The machine's memory is full.	Either print or delete documents in memory (see "Printing the MEMORY LIST" on page 76) to free up memory. Then ask the sender to resend the fax.
There was an error during reception.	<ul style="list-style-type: none"> ● Check the LCD for an error message (See "Fax Related Messages" on page 118). ● Print the ACTIVITY REPORT and check for an error (See "Printing the ACTIVITY REPORT" on page 71).
The telephone line is not correctly connected.	Check that the telephone line is connected correctly to [LINE] and that the telephone (or another external device such as an answering machine or a computer modem) is connected correctly to [TEL]. Refer to the <i>Easy Setup Instructions</i> .
A paper size other than A4, LTR or LGL* is loaded.	<p>If a paper size other than A4, LTR or LGL* is loaded in the configured paper source, incoming faxes are not printed and are stored in memory. Change the paper in the configured paper source to A4, LTR or LGL* size, then press [OK] on the machine.</p> <p>Load legal-size paper in the Auto Sheet Feeder.</p>
The receive mode is incorrect.	<p>Check the receive mode of your machine, then specify the receive mode properly according to your environment.</p> <p>FAX ONLY MODE: See "If You Want to Receive Only Faxes Automatically with Your Machine, or You Have a Dedicated Telephone Line for Fax Use Only:" on page 80.</p> <p>MANUAL MODE: See "If You Receive Mainly Voice Calls and Sometimes Faxes, or You Want to Receive Faxes Manually:" on page 80.</p> <p>ANS.MACHINE MODE: See "If You Want to Receive Voice Messages on Your Answering Machine and Receive Faxes Automatically:" on page 81.</p> <p>FAX/TEL AUTO SW: See "If You Want to Receive Faxes Automatically as well as Voice Calls:" on page 81.</p> <p>DRPD: See "If You Have Subscribed to a Distinctive Ring Pattern Detection (DRPD) Service with Your Telephone Company (US and Canada only):" on page 82.</p> <p>NETWORK SWITCH: See "If You Want Your Machine to Automatically Switch between Fax and Voice Calls by the Call Ring Patterns (Network Switch) (This setting is not available in some countries and regions.):" on page 82.</p>

* LGL may not be available depending on the country of purchase.

■ Cannot Receive Faxes Automatically

Cause	Action
The receive mode displayed on the bottom left of the LCD is not <FAX ONLY>, <DRPD> ¹ , <NET SW.> ² , <ANSMODE>, or <FAX/TEL>.	<p>If <MANUAL> is displayed, you cannot receive faxes unless you pick up the answering machine's handset and either press [Color] or [Black], or dial the remote receiving ID.</p> <p>If you want to receive faxes automatically, which means not having to do anything when you receive a fax, set the receive mode to <FAX ONLY MODE>, <DRPD>¹, <NETWORK SWITCH>², <ANS.MACHINE MODE>, or <FAX/TEL AUTO SW> (See "Receive Modes" on page 80).</p> <p>If the receive mode is <ANS.MACHINE MODE>, connect an answering machine to the machine (see the <i>Easy Setup Instructions</i>) and check that a message plays back when the answering machine answers.</p>

¹ This setting is only available in US and Canada.

² This setting is not available in some countries and regions.

■ Machine Does Not Switch Automatically between Voice and Fax Calls

Cause	Action
The receive mode displayed on the bottom left of the LCD is not <DRPD> ¹ , <NET SW.> ² , <ANSMODE> or <FAX/TEL>.	<p>There will be no automatic switching between voice and fax calls unless the receive mode is set to <DRPD>¹, <NETWORK SWITCH>², <ANS.MACHINE MODE> or <FAX/TEL AUTO SW>.</p> <p>If the receive mode is <ANS.MACHINE MODE>, connect an answering machine to the machine (see the <i>Easy Setup Instructions</i>) and check that a message plays back when the answering machine answers.</p>

¹ This setting is only available in US and Canada.

² This setting is not available in some countries and regions.

■ Quality of Received Fax is Poor

Cause	Action
<ECM RX> is set to <OFF>.	Set <ECM RX> to <ON> (See "ECM RX" on page 95).
The sender's original document or fax machine is dirty.	The image quality of the fax is mainly determined by the sender's fax machine. Contact the sender and check whether the scanning area of his/her fax machine is not dirty.
ECM sending/receiving is not enabled although the line/connection is poor.	<ul style="list-style-type: none"> ● On your machine, set <ECM RX> to <ON> (See "ECM RX" on page 95). ● Contact the sender and check that his/her machine is set to enable ECM sending. ● If the sender's or receiver's fax is not ECM-compatible, the fax will be sent/received in the standard mode. ● Reduce the reception start speed. See "RX START SPEED" on page 96.

■ Repeated Errors Occur When You Receive a Fax

Cause	Action
The telephone line condition or connection condition is no good.	Reduce the reception start speed (See "RX SETTINGS" on page 95). If there is a poor line or connection, reducing the reception start speed may correct the error.
The sender's fax machine is not operating normally.	Contact the sender and check whether his/her fax machine is operating normally.

Problems Sending Faxes

■ Cannot Send a Fax

Cause	Action
The machine is not on.	<ul style="list-style-type: none"> You cannot send faxes if the power is turned off. Press [ON/OFF] to turn the power on. See “Turning the Machine ON and OFF” on page 18. After a power failure or disconnecting of the power cord, press [ON/OFF] to turn the power ON.
The In Use/Memory Lamp is flashing.	Another document is being sent from memory. Wait until the machine finishes sending it.
The telephone line is connected to the [TEL] jack.	Reconnect to the [LINE] jack (Refer to the <i>Easy Setup Instructions</i>). If you still cannot send a fax, there is a problem with the telephone line. Contact your telephone company or the manufacturer of your TA (Terminal Adapter) or telephone adapter.
The telephone line type is not set correctly.	If the telephone line type is not set correctly, you will not be able to send faxes, but will still be able to receive them. In this case, check the telephone line type setting and change it as necessary. See “Setting the Telephone Line Type” on page 62.
<DIAL TONE DETECT> is set to <ON>.	Send faxes again after a while. If you still cannot send faxes, set <DIAL TONE DETECT> to <OFF>.
The fax number is not correctly registered in a coded speed dial.	Make sure that the fax number is correctly registered when coded speed dialing (See “Registering Coded Speed Dialing” on page 65).
There was an error during transmission.	<ul style="list-style-type: none"> Check the LCD for an error message (See “Fax Related Messages” on page 118). Print the ACTIVITY REPORT and check for an error (See “Printing the ACTIVITY REPORT” on page 71).
Cannot hear the dial tone.	Check that the telephone line is correctly connected to the proper jack. If so, there is a problem with your telephone line. Contact your telephone line provider.
The document is not loaded properly.	Remove the document then reload it on the Platen Glass or in the ADF (See “Loading Documents” on page 19).
A fax destination is displayed on the LCD.	Another document is being sent from memory. Wait until the machine finishes sending it.
There was a printer error.	Resolve the printer error. If you are out of paper, set the paper. If you are in a hurry, you can send the fax before resolving the printer error by pressing [Stop/Reset]. In this case, be sure to press [FAX] to print the faxes stored in memory once the transmission is complete.

■ Cannot Send a Fax Clearly

Cause	Action
The document is not loaded correctly, or the Platen Glass or the inner side of the Document Cover is dirty.	<ul style="list-style-type: none"> Remove the document, then reload it on the Platen Glass or in the ADF (See “Loading Documents” on page 19). Reload the document after cleaning the Platen Glass or the ADF (See “Cleaning Your Machine” on page 107).
The setting for image quality or intensity is not suitable for the document.	On the LCD, adjust the setting for image quality (FAX Resolution) or intensity (Scan Contrast) suitable for the document (See “Before Sending Faxes” on page 72).

Cause	Action
The document is not loaded with the side to be scanned face down.	When loading the document on the Platen Glass, the side to be scanned should be face down. When loading in the ADF, the side to be scanned should be face up.
You are scanning thick (max. 10 mm / 0.39") or curled documents.	Press on the Document Cover with your hand when scanning.

■ Repeated Errors Occur When You Send a Fax

Cause	Action
The telephone line condition or connection condition is no good.	Reduce the transmission start speed (See "TX START SPEED" on page 95). If there is a poor line or connection, reducing the transmission start speed may correct the error.

Telephone Problems

■ Cannot Dial

Cause	Action
The telephone line is not correctly connected.	Check that the telephone line is correctly connected (Refer to the <i>Easy Setup Instructions</i>).
The telephone line type is not set correctly.	Make sure the machine is set for the correct telephone line type (See "Setting the Telephone Line Type" on page 62).

■ Telephone Disconnects During a Call

Cause	Action
The power cord, the telephone line, or the telephone (or another external device such as an answering machine or a computer modem) is not connected securely.	Check that the power cord, the telephone line, and the telephone (or another external device such as an answering machine or a computer modem) are connected securely.



Problems Scanning

■ Scanner Won't Work

Cause	Action
The machine is not recognized by the computer.	Restart the computer. This may enable the computer to recognize the machine.

■ ScanGear MP Won't Start

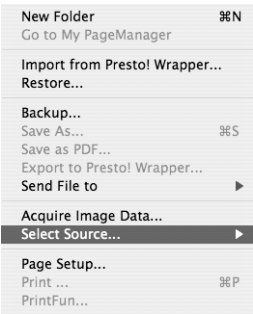
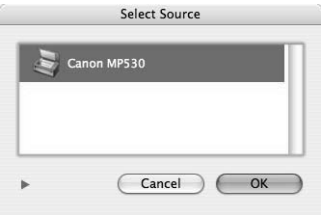

Cause	Action
Scanner driver (ScanGear MP) not installed.	Set the Setup CD-ROM and install the software.

Cause	Action
<p>Scanner is not selected in the application software.</p>	<p>In the application software, select this machine in [Select Source] or [Import] under the [File] menu. Example: Presto! PageManager</p> <p>Windows</p>   <p>Display may differ depending on your operating system. If you are using an older application software, the menu item may be named [Select TWAIN-compliant device] instead of [Select Source].</p> <p>Macintosh</p>  
<p>The Feature of the application software does not support TWAIN.</p>	<p>Start ScanGear MP from within a TWAIN compatible software.</p>
<p>An error message appears and the ScanGear MP window fails to appear.</p>	<ul style="list-style-type: none"> ● Reattaching the USB cable. Be sure to use a certified USB 2.0 Hi-Speed cable. You are recommended to use the cable no longer than 3 meters (9.8 feet). ● If a USB hub is used for the connection, do not use it. Attach the cable to a USB port on the computer itself (not the hub). ● Attach the USB cable to a different USB port on the computer itself (not a hub). ● Set the Setup CD-ROM and install the software. ● Select this machine in [Select Source] or [Import] in your application software. ● Make sure that your application software supports TWAIN. You cannot start ScanGear MP from within an application software that does not support TWAIN.

■ Computer Stops Operating During Scanning

Cause	Action
Output Resolution set too high.	Reboot the computer, lower the Output Resolution and rescan.
The hard disk does not have enough available space.	<ul style="list-style-type: none"> ● Reset and reboot the computer, delete unnecessary files and application softwares, and rescan. ● Open ScanGear MP from within the application software, click the [Preferences] button in the Advanced Mode, and change the folder listed in the [Select Folder Where Temporary Files are Saved] category to one on a disk with sufficient free space.
Multiple devices connected to the USB port.	Disconnect all other devices but the machine from the port.

■ Scan Quality is Poor (Poor Image Displayed on the Monitor)

Cause	Action
The resolution is low.	If the image looks grainy, increase the scan resolution. For details, refer to the <i>Scan Guide</i> .
Specification of the application software.	Some application software does not display the image clearly if the image is too small. Set the view mode to 100%.
Moiré appears.	Set [Descreen] to [ON] in the [Image Settings] section of the Advanced Mode of ScanGear MP.  Note Moiré may appear when you scan digital photo prints.
Inappropriate display settings.	<p>Windows</p> <p>Set your display settings on your computer to Medium (16 bit) or higher. In the [Start] menu click [Control Panel], then [Appearance and Themes] and then [Display], and on the [Settings] sheet, set [Color quality] to [Medium (16 bit)] or [Highest (32 bit)] or a higher setting.</p> <p>Macintosh</p> <p>In the [System Preferences] dialog, click the [Displays] icon and select the [Display] tab. Set the [Colors] list box to [Thousands] or a higher setting.</p>
Dirty Platen Glass or inner side of the Document Cover.	See “Cleaning Your Machine” on page 107 to clean them.
The status of the original is poor.	Scan with certain functions such as [Reduce Dust and Scratches], [Fading Correction] or [Grain Correction] in the [Image Settings] section of the Advanced Mode of ScanGear MP.  Note If a print out of an image does not appear satisfactory or the same as what you see on the monitor, you may need to change the machine's settings, or the machine itself may have engaged in problems.

■ Parts of Image Missing or Surrounded by Extra White Areas

Cause	Action
Scan area was specified larger than the original.	Specify the scan area appropriately. If you click the Auto crop button of the ScanGear MP, the scan area is adjusted automatically to match the size of the original. When scanning an original surrounded by white borders such as a photo print, or if you otherwise want to specify a custom scan area, specify the scan area manually. Refer to the <i>Scan Guide</i> for details on manual scan area specification.

■ Trouble Scanning with Multi-Scan or Multi-Crop Function

Cause	Action
The original is positioned outside the supported area.	Check the position of the original on the Platen Glass. Observe the following when using the Multi-Scan or Multi-crop function. <ul style="list-style-type: none"> ● There should be a gap of at least 10 mm / 0.4" between the edge of the Platen Glass and originals. ● Leave at least 10 mm / 0.4" between the originals. ● A maximum of 10 originals can be scanned at once. ● If an original is slightly crooked on the Platen Glass-within 10 degrees of true-the image is automatically straightened. ● The Multi-Scan function only works with rectangular originals such as photos. ● Originals that are not rectangular (irregularly shaped, close-cropped photos) cannot be detected correctly. ● Originals must be at least as large as approx. 25 mm / 1" square.
Error arising from application software specifications.	Some application software do not support multiple image scanning. Scan each item individually without using the Multi-Scan or Multi-Crop function.

■ Slow Scanning Speed

Cause	Action
Resolution is set higher than necessary.	To view the image on a monitor, set the output resolution to 75 dpi. To print, set the output resolution to a value such as 300 dpi.
Image correction features such as dust and scratch reduction, fading correction, and descreening are enabled in ScanGear MP.	Set [Reduce Dust and Scratches], [Fading Correction], and [Descreen] to [OFF] in the [Image Settings] section of the Advanced Mode of ScanGear MP.

Macintosh

■ "There is not enough memory." Message is Displayed

Cause	Action
There is not enough memory to continue scanning.	Exit any application software that are running, and try to run this software again.

■ Scanned Image not Displayed Properly

Cause	Action
Scanned image prints out enlarged (reduced).	Set the printing size in the application software.
Scanned image enlarged (reduced) on the computer monitor.	<ul style="list-style-type: none"> ● Change the display setting in the application software.  <ul style="list-style-type: none"> ● Images opened in [Paint] or [Imaging] may be displayed in full size and you may not be able to reduce its display size. Open the image in an application software supplied with the scanner instead. Refer to the on-screen manual for each application software for the detailed procedures. ● Change the resolution setting in the scanner driver and rescan. The higher the resolution, the larger the resulting image will be. ● Some application softwares do not display clear images at small image display settings. Set the scale to 100%.
Scanned image won't open.	The file name extension is not supported by the application software. Rescan the image using an application software, such as PageManager, and change the file name extension when saving the image. Refer to the on-screen manual for each application software for the detailed procedures.

■ Trouble scanning with MP Navigator

Cause	Action
The original may not be scanned correctly when [Document Size] is set to [Auto Detect].	Set the [Document Size] to the actual size of the original, and scan it again. If the size you need cannot be set, scan to a larger size and trim it. For more information, refer to the <i>Scan Guide</i> .

■ Image position and size incorrect when scanning from the machine's operation panel

Cause	Action
MP Navigator settings do not match the originals.	Set the MP Navigator [Document Type] and [Document Size] to match those of the originals being scanned. For more information, refer to the <i>Scan Guide</i> .

■ Scanned image is slanted although document is set properly

Cause	Action
When the [Correct the inclination of text documents] check box is selected, scanning may not be performed properly depending on the document.	Clear the [Correct the inclination of text documents] check box in MP Navigator, then rescan the document. For more information, refer to "[Scan Settings] Dialog Box" under "Using MP Navigator" in the <i>Scan Guide</i> .

■ Scanned image is rotated although document is set properly

Cause	Action
When the [Detect the orientation of text documents and rotate images] check box is selected, scanning may not be performed properly depending on the document.	Clear the [Detect the orientation of text documents and rotate images] check box in MP Navigator, then rescan the document. For more information, refer to "[Scan Settings] Dialog Box" under "Using MP Navigator" in the <i>Scan Guide</i> .

An Error Message Appears on the Screen



■ Service Error 5100 is Displayed

Cause	Action
Movement of the Print Head Holder is blocked.	Clear the paper jam or foreign object that is preventing the Print Head Holder from moving, cancel printing from your computer, then turn off the machine and turn it back on again.





■ Writing Error/Output Error/Communication Error

Cause	Action
Machine is not ready.	Ensure that the lamp on the Operation Panel lights. If the lamp on the Operation Panel is off, turn the machine on. While [COPY] is flashing, the machine is initializing. Wait until [COPY] stops flashing and stays lit. When the Alarm Lamp is lighting or flashing orange, an error may occur in the machine. For details on how to resolve the error, see "An Error Message is Displayed on the LCD" on page 113.
Paper is not loaded.	Load paper and press the [OK]. If paper is loaded, ensure that the paper source (the Auto Sheet Feeder or Cassette) is selected correctly. If the paper source is not selected correctly, use [Feed Switch] or the printer driver to change the paper source. If this error (Paper is not loaded) is ignored for a certain period of time, an additional message may be displayed.
Printer port setting does not match the interface connected to the machine.	Check the printer port settings. 1. Click [Start] and select [Control Panel], [Printers and Other Hardware], and then [Printers and Faxes]. For non-Windows XP, click [Start], select [Settings], and then [Printers]. 2. Select the icon of your machine. 3. Open the [File] menu and select [Properties]. 4. Click the [Ports] tab (or the [Details] tab) to confirm the port settings. A USB port is selected if either [USBn (Canon MP530 Series Printer)] or [MPUSBPRNn (Canon MP530 Printer)] (where n is a number) is indicated. If the port setting is not correct, change the port setting according to the interface you are using on the [Ports] tab (or the [Details] tab), or reinstall the MP Drivers.
Machine is not properly connected.	Ensure that the printer cable is securely connected to the computer. ● If using a switching hub or other device, disconnect the machine and reconnect it directly to the computer and try printing again. If successful, the problem may have been with the device. ● There could also be a problem with the cable(s). Replace the cable(s) and try printing again.

Cause	Action
MP Drivers is not installed properly.	<p>Uninstall then reinstall the MP Drivers.</p> <ol style="list-style-type: none"> 1. Click [Start], and select [All Programs] (or [Programs]), the name of your machine, and [Uninstall]. 2. Follow the on-screen instructions to uninstall the driver. 3. Follow the procedures described in the <i>Easy Setup Instructions</i> and reinstall the MP Drivers.

■ When an Error is Displayed Regarding Automatic Duplex Printing

Cause	Action
The correct media size is not selected in the printer driver.	<p>Check the page size setting from within your application software to ensure that it matches the size of the paper loaded.</p> <p>Check [Page Size] on the [Page Setup] tab in the printer properties dialog box (Windows) or the [Page Setup] dialog box (Macintosh) to ensure that it matches the size of the paper loaded.</p> <p>The page sizes that can be used for Automatic Duplex Printing are Letter, A4, B5, A5, and 5" x 7" / 127.0 x 177.8 mm. Check that the page size of the loaded paper is correct.</p> <p> Note</p> <p>To print on both sides of the page manually, follow the procedure below.</p> <p> Windows</p> <p>On the [Page Setup] tab, clear the [Automatic] check box. Then try printing again.</p> <p> Macintosh</p> <p>The manual duplex printing function cannot be used.</p>

Macintosh

■ Error No.: 300 is Displayed

Cause	Action
The machine is not ready.	<p>Ensure that the lamp on the Operation Panel lights.</p> <p>If the lamp on the Operation Panel is off, turn the machine on.</p> <p>While [COPY] is flashing, the machine is initializing. Wait until [COPY] stops flashing and stays lit.</p> <p>When the Alarm Lamp is lighting or flashing orange, an error may occur in the machine. For details on how to resolve the error, see "An Error Message is Displayed on the LCD" on page 113.</p>
Machine is not properly connected.	<p>Ensure that the printer cable is securely connected to the computer.</p> <ul style="list-style-type: none"> ● If using a switching hub or other device, disconnect the machine and reconnect it directly to the computer and try printing again. If successful, the problem may have been with the device. ● There could also be a problem with the cable(s). Replace the cable(s) and try printing again.

Cause	Action
<p>The name of the machine being used is not selected in the [Printer] pull-down menu of the [Print] dialog box.</p>	<p>Select [MP530] from the [Printer] pull-down menu in the [Print] dialog box of the printer driver.</p> <p>If [MP530] is not displayed in the printer list, follow the procedure below to confirm the settings.</p> <ol style="list-style-type: none"> 1. Select [Print & Fax Preferences] from the [Printer] pop-up menu. 2. Check that [MP530] is displayed in the screen that is displayed. <p>When you are using Mac OS X v.10.3.x or Mac OS X v.10.2.x, select [Edit Printer List] from the [Printer] pull-down menu and ensure that [MP530] is displayed in the [Printer List] and select the check box.</p> <ol style="list-style-type: none"> 3. If [MP530] is not displayed, click [+] to add a printer. <p>If [MP530] is not displayed, install the MP Drivers again referring to the <i>Easy Setup Instructions</i> for the operation.</p>

Macintosh

■ Error No.: 1700 is Displayed

Cause	Action
<p>The waste ink absorber is almost full.</p>	<p>Ink used for cleaning is absorbed in a waste ink absorber placed in the machine.</p> <p>Press [OK] to cancel the error so that you can continue printing. Once the waste ink absorber becomes completely full, printing cannot be done until the waste ink absorber is replaced.</p> <p>Canon recommends to contact the Canon Customer Care Center as soon as possible.</p>

Macintosh

■ Error No.: 1851 is Displayed

Cause	Action
<p>Inner Cover is open when starting regular printing.</p>	<p>Close Inner Cover, then press [OK] on the machine.</p>

Macintosh

■ Error No.: 1856 is Displayed

Cause	Action
<p>During regular printing, Inner Cover is opened.</p>	<p>Close Inner Cover, press [OK] on the machine, then try printing again.</p> <p>One page of the print data being sent at the time of the error will be erased, so print that page again.</p>

Macintosh

■ Error No.: 2001 is Displayed

Cause	Action
A specified period of time has elapsed without receiving a response from the digital camera./ The digital camera or digital video camcorder connected is not compatible with this machine.	<p>Disconnect the camera cable and reconnect it.</p> <p>Depending on the model or brand of your device, you may have to select a print mode compliant with PictBridge before connecting the device.</p> <p>You may also have to turn on the device or select Play mode manually after connecting the device to the machine. Unplug the connecting cable and clear the error. Perform necessary operations for connection referring to the instruction manual supplied with the PictBridge compliant device, and then connect the cable again.</p> <p>If the error is still unresolved, there is a possibility that you are using a digital camera or digital video camcorder that is not supported by this machine. Use a digital camera or digital video camcorder compatible with this machine.</p>



Macintosh

■ Error No.: 2500 is Displayed

Cause	Action
Auto head align has failed.	See "HEAD ALIGNMENT ERROR" on page 115.

Windows

■ For Windows Users

Cause	Action
The [Instructions] button is not displayed on the printer driver screen.	<p>The [Instructions] on the printer driver screen is not displayed if the On-screen Manuals (instruction manuals) are not installed. Set the "Setup CD-ROM" in your computer and install the On-screen Manuals (instruction manuals).</p> <p> Note The [Instructions] is displayed only on [Main] and [Maintenance] tabs.</p>
Scan Guide is not displayed.	The  button for displaying the scanner driver operating instruction is grayed out when the On-screen Manuals (instruction manuals) are not installed. Set the "Setup CD-ROM" in your computer and install the On-screen Manuals (instruction manuals).

If You Cannot Resolve the Problem

If you cannot resolve the problem with any of the workarounds in this chapter, please contact the Canon Customer Care Center.

Canon support staff are trained to be able to provide technical support to satisfy customers.

Caution

Attempts by customers to repair or take apart the machine will invalidate any warranty regardless of whether the warranty has expired.

Before contacting the Canon Customer Care Center, confirm the following:

- Product name: PIXMA MP530
- Serial number: located inside the machine

- Details of the problem
- What you tried to solve the problem, and what happened

 **Note**

If the machine emits any unusual sound, smoke, or odor, turn it off immediately. Unplug the power cord from the outlet and contact the Canon Customer Care Center. Never attempt to repair or disassemble the machine yourself.

Chapter 10

Appendix

Printing Area

To ensure the best print quality, the machine allows a margin along each edge of media. The actual printable area will be the area without these margins. By selecting Borderless Printing*, printing with no margins is possible.

* This is available in A4, Letter, 4" x 6" / 101.6 x 152.4 mm, 4" x 8" / 101.6 x 203.2 mm, 5" x 7" / 127.0 x 177.8 mm, and 2.13" x 3.39" / 54.0 x 86.0 mm sizes of paper. If you are copying, you can adjust the amount of image that extends off the paper in borderless copy by setting <EXTENDED AMOUNT> under <PRINT SETTINGS>.

Note

- In duplex printing, the printable area at the top of the page is 2 mm / 0.08" narrower than the usual area.
- If you print fully on the printable area outside of the recommended printing area, print quality or paper feeding accuracy may go down.

A5, A4, B5, 4" x 6", 4" x 8", 5" x 7", 2.13" x 3.39"

Size	Printable Area (width x height)
A5	5.6" x 7.9" / 141.2 x 202.0 mm
A4	8.0" x 11.4" / 203.2 x 289.0 mm
B5	6.9" x 9.8" / 175.2 x 249.0 mm
5" x 7" / 127.0 x 177.8 mm	4.7" x 6.7" / 120.2 x 169.8 mm
4" x 6" / 101.6 x 152.4 mm	3.7" x 5.7" / 94.8 x 144.4 mm
4" x 8" / 101.6 x 203.2 mm	3.7" x 7.8" / 94.8 x 195.2 mm
2.13" x 3.39" / 54.0 x 86.0 mm	1.86" x 3.07" / 47.2 x 78.0 mm

Note

When printing on Photo Paper Pro PR-101, Glossy Photo Paper GP-401, Glossy Photo Paper "Everyday Use" GP-501, Photo Paper Plus Glossy PP-101, Photo Paper Plus Double Sided PP-101D, Photo Paper Plus Semi-gloss SG-101, and Matte Photo Paper MP-101 selection of "Borderless Printing" enables you to make prints with no margins.

However, Borderless Printing may reduce the print quality on the top and bottom edges of the paper or cause it to become smudged.

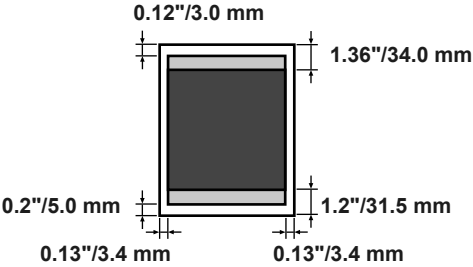

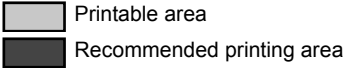

■ Letter, Legal

Size	Printable Area (width x height)
Letter	8.0" x 10.7" / 203.2 x 271.4 mm
Legal	8.0" x 13.7" / 203.2 x 347.6 mm

Note

When printing on Photo Paper Pro PR-101, Glossy Photo Paper GP-401, Photo Paper Plus Glossy PP-101, Photo Paper Plus Double Sided PP-101D, Photo Paper Plus Semi-gloss SG-101, and Matte Photo Paper MP-101 selection of "Borderless Printing" enables you to make prints with no margins.

However, Borderless Printing may reduce the print quality on the top and bottom edges of the paper or cause it to become smudged.

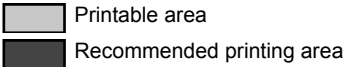
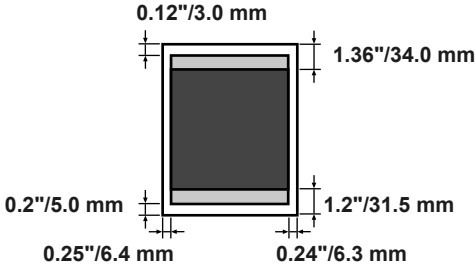

■ Envelopes

Size	Printable Area (width x height)
European DL	7.5" x 4.1" / 190.5 x 103.2 mm
US Com. #10	8.3" x 3.9" / 211.8 x 98.0 mm

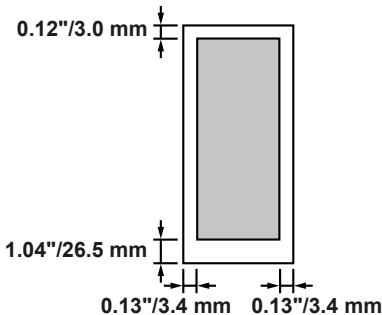

How to Read the On-screen Manuals

The on-screen manuals are manuals to be viewed on your computer.

Read these manuals for detailed information on usage of the machine that is not mentioned in this document, troubleshooting, or usage of the application softwares supplied with the Setup CD-ROM, etc.

If you have not installed or have deleted the on-screen manuals, you can install them using the Setup CD-ROM by either of the following.

- Select “Easy Install” to install the on-screen manuals along with the MP driver and application softwares.
- Select “On-screen Manual” from “Custom Install” to install the on-screen manuals.

Windows

Browser: Windows® HTML Help Viewer

Note

- Microsoft Internet Explorer 5.0® or later must be installed.
- The on-screen manual may not be displayed properly depending on your operating system or Internet Explorer version. We recommend that you keep your system up to date with Windows Update.

Macintosh

Browser: Help Viewer

Note

- The on-screen manual may not be displayed properly depending on your operating system. We recommend that you keep your system up to date.
- We recommend using Safari as your Web browser to view the HTML format On-screen Manuals. If Safari is not installed on your computer, download it from Apple Computer, Inc. website and install it.

Uninstalling the On-screen Manuals

Follow the steps described below to uninstall all of the installed On-screen Manuals from your computer.

Windows

If the On-screen Manuals have been installed, all of them will be deleted collectively.

- 1** Click the [Start], and select [All Programs] (or [Programs]), [Canon MP530 Manual], and then [Uninstall].
- 2** Click [OK] when the confirmation message appears.
When the message prompting you to restart your computer is displayed, click [OK] to restart your computer.

● Deleting the Printer Driver Guide

The *Printer Driver Guide* is deleted when the printer driver is deleted.

● Deleting the User's Guide and the Photo Application Guide

- (1) Select [Applications] from the [Go] menu.
- (2) Double-click the [Canon Utilities] folder, and then the [IJ Manual] folder.
- (3) Drag the [MP530] folder into the trash.
- (4) Drag the [MP530 On-screen Manual] on your desktop into the trash.

Transporting Machine

When relocating the machine or storing the machine for a long period of time, pack the machine using the original packing materials. If you do not have the original packing materials, pack the machine carefully using protective material and place inside a sturdy box.

Caution

Do not transport or store the machine on a slant, vertically or upside-down, as the ink may leak from the machine and cause damage to it.

Important

Pack the machine with the Print Head and ink tanks left installed.

Note

Before shipping the machine by special delivery or post, clearly label the box as “FRAGILE” or “HANDLE WITH CARE.”

Specifications

General Specifications

Printing resolution	9600 * x 2400 dpi. max. * Ink droplets can be placed with a pitch of 1 / 9600 inch at minimum.
Print speed * *Print speed may vary with the content of the document and the processing speed of the host computer.	Black printing (text pattern) Max Speed (Custom Setting 5): 29 ppm Standard: 15 ppm Color printing Max Speed (Custom Setting 5): 19 ppm Standard: 11 ppm
Print width	203.2 mm max. (8.0") (for Borderless Printing: 8.5" / 216 mm)
Resident print control mode	Canon extended mode
Receive buffer	42 KB
Interface	USB 2.0 Hi-Speed/Direct Print Port * All operations are not guaranteed for computers standard-equipped with a USB 2.0 Hi-Speed interface. * Since the USB 2.0 Hi-Speed interface is upwardly compatible with USB Full-Speed (USB 1.1), it can be used at USB Full-Speed (USB 1.1).
Acoustic noise level	Approx. 34.5 dB (A) (in the highest print quality mode)
Operating environment	Temperature: 5 to 35°C (41 to 95°F) Humidity: 10 to 90%RH (no condensation)
Storage environment	Temperature: 0 to 40°C (32 to 104°F) Humidity: 5 to 95% RH (no condensation)
Power supply	AC 110-240 V, 50/60 Hz
Power consumption	Printing (Copy): Approx. 22 W Standby: Approx. 3.9 W OFF: Approx. 0.9 W
Dimensions (with the Paper Support and Paper Output Tray retracted)	18.4 (W) x 18.4 (D) x 10.4 (H) inches 468 (W) x 467 (D) x 263 (H) mm
Weight	12.8 kg (28.2 lb)
Print Head	Black (PGI-5BK): 320 (160 x 2) nozzles Cyan, Magenta, Yellow, Black (CLI-8BK): 1536 (128 x 2 x 6) nozzles
ADF capacity	* Max. 30 pages of A4- or letter-size sheets (20 lb / 75 gsm paper), up to 4 mm in height * Max. 10 pages of legal-size sheets (20 lb / 75 gsm paper), up to 2 mm in height * 1 sheet for sizes other than these

Copy Specifications

Copy speed	Black & white: <Fast> mode approx. 28 cpm
*Based on Canon standard pattern. Copy speed may vary depending on document complexity, copy mode, page coverage and the number of copies.	Color: <Fast> mode approx. 19 cpm
No. of copies	Maximum 99 copies
Density adjustment	9 levels
Zoom	25% to 400%

Fax Specifications

Applicable line	Public Switched Telephone Network (PSTN)
Compatibility	G3 / Super G3 (Mono & Color Fax)
Data compressing system	MH, MR, MMR, JPEG
Modem type	Fax modem
Modem speed	33600 / 31200 / 28800 / 26400 / 24000 / 21600 / 19200 / 16800 / 14400 / 12000 / 9600 / 7200 / 4800 / 2400 bps Automatic fallback
Transmission speed	Black & white: Approx. 3 seconds/page at 33.6 Kbps, ECM-MMR, transmitting from memory (Based on ITU-T No.1 chart for US specifications and Canon FAX Standard chart No.1 for others, both in standard mode or Canon FAX Standard chart No1, standard mode.) Color: Approx. 1 minute 20 seconds/page at 33.6 Kbps, ECM-JPEG, transmitting from memory (Based on Canon COLOR FAX TEST SHEET.)
Scanning image processing	Halftones: 256 levels of gray Density adjustment: 3 levels
Memory	Transmission/reception: 150 pages (Based on ITU-T No.1 chart for US specifications and Canon FAX Standard chart No.1 for others, both in standard mode.)
Fax resolution	Black & white <STANDARD>: 203 pels / in. x 98 lines / in (8 pels / mm x 3.85 lines / mm.) Black & white <FINE>, <PHOTO>: 203 pels / in. x 196 lines / in (8 pels / mm x 7.70 lines / mm.) Color: 200 x 200 dpi
Dialing	Automatic dialing Coded speed dialing (40 destinations) Regular dialing (with numeric buttons) Automatic redialing Manual redialing (with [Redial/Pause])

Fax Specifications

Networking	Automatic reception Automatic fax/tel switchover DRPD (Distinctive Ring Pattern Detection) Remote reception by telephone (Default ID: 25) Non-ring reception ECM deactivation ACTIVITY REPORT (after every 20 transactions) Non-delivery report TTI (Transmit Terminal Identification)
-------------------	--

Telephone Specifications

Connection	Telephone/answering machine (CNG detecting signal)/data modem
-------------------	---

Camera Direct Print (PictBridge)

Paper size	Default (Selections based on the machine setting) 10 x 15 cm / 4" x 6" (Photo Paper Plus Glossy, Photo Paper Pro, Photo Paper Plus Semi-gloss, Glossy Photo Paper, Glossy Photo Paper "Everyday Use", Photo Stickers ¹) 13 x 18 cm / 5" x 7" (Photo Paper Plus Glossy) ² A4 / 8.5" x 11" (Photo Paper Plus Glossy A4/Letter, Photo Paper Pro A4/Letter, Photo Paper Plus Semi-gloss A4/Letter, Glossy Photo Paper A4/Letter, Glossy Photo Paper "Everyday Use" A4, Plain Paper A4/Letter) 5.4 x 8.6 cm / Credit Card (Glossy Photo Paper Card Size) ¹ Canon-brand sticker. Printing on this paper is available only when the Layout function on your camera has a 16-up option. See "Recommended Paper and Requirements" on page 22. ² If using a Canon PictBridge-compatible camera, you can select it.
Paper type	Default (Selections based on the machine setting), Photo (Photo Paper Plus Glossy, Photo Paper Plus Semi-gloss, Glossy Photo Paper, Glossy Photo Paper "Everyday Use", Photo Stickers), Fast Photo (Photo Paper Pro), Plain Paper (Only A4/Letter)
Layout	Default (Selections based on the machine setting), Borderless, Bordered, N-up (2, 4, 9, 16)* * Layout compatible with Canon-brand sticker above. See "Recommended Paper and Requirements" on page 22.
Trimming	Default (Off: No trimming), On (follow camera's setting), Off
Image optimize	Default (Selections based on the machine setting), On, Off, "VIVID"* , "NR" (Noise Reduction)*, "VIVID+NR"* , "Face"* * If using a Canon PictBridge-compatible camera, you can select it.
Print date & file no.	Default (Off: No printing), Date, File No., Both, Off

Camera Direct Print (Canon Bubble Jet Direct)

Compatible paper	<p>Card #1 (Photo Paper Pro 4" x 6" / 101.6 x 152.4 mm)</p> <p>Card #2 (Photo Paper Plus Glossy, Photo Paper Plus Semi-gloss, Glossy Photo Paper, or Glossy Photo Paper "Everyday Use" 4" x 6" / 101.6 x 152.4 mm)</p> <p>Card #3 (Photo Paper Plus Glossy 5" x 7" / 127.0 x 177.8 mm)</p> <p>LTR (Photo Paper Pro, Photo Paper Plus Glossy, Photo Paper Plus Semi-gloss, or Glossy Photo Paper Letter size)</p> <p>A4 (Photo Paper Pro, Photo Paper Plus Glossy, Photo Paper Plus Semi-gloss, Glossy Photo Paper, or Glossy Photo Paper "Everyday Use" A4 size)</p>
Layout print	Standard: Borderless/with border
Effect	ExifPrint
DPOF functions	Ver. 1.00 compatible (number of copies, select images, print special characters (date))

Scan Specifications (Platen Glass)

Compatibility	TWAIN/WIA (Windows XP)
Maximum document size	A4/Letter, 8.5" x 11.7" / 216 x 297 mm
Scanning resolution	<p>1200 dpi x 2400 dpi optical</p> <p>19200 dpi x 19200 dpi enhanced</p>
Scanning image processing	<p>Halftones: 256 levels of gray</p> <p>Color: 16,777,216 colors</p>

Minimum System Requirements¹

Windows²

Interface	Operating System	Processor	RAM	Hard Disk Space
USB 2.0 Hi-Speed	Windows XP SP1, SP2 Windows 2000 Professional SP4	PentiumIII ³ (Celeron 566 MHz)	128 MB	450 MB
USB	Windows XP SP1, SP2 Windows 2000 Professional SP2, SP3, SP4 Windows Millennium Edition Windows 98 ⁴ , 98 Second Edition	PentiumII 300 MHz ³	128 MB	450 MB

Macintosh

Interface	Operating System	Processor	RAM	Hard Disk Space
USB 2.0 Hi-Speed	Mac OS X v.10.4	PowerPC G4/ G5	256 MB	500 MB
	Mac OS X v.10.2.8 - v.10.3	PowerPC G4/ G5	128 MB	500 MB

Minimum System Requirements^{*1}

USB	Mac OS X v.10.4	PowerPC G3/ G4/G5	256 MB	500 MB
	Mac OS X v.10.2.8 - v.10.3	PowerPC G3/ G4/G5	128 MB	500 MB

*1 For updated compatibility, visit our website.

*2 Operation can only be guaranteed on a computer with built-in USB or USB 2.0 Hi-Speed port and pre-installed Windows XP, 2000, Me or 98.

*3 Including compatible processors.

*4 ScanSoft OmniPage SE (OCR software) does not support Windows 98 first edition.

- CD-ROM drive
- Display : SVGA 65,000 colors

Additional System Requirements for On-screen Manuals

Windows

- **Browser: Windows HTML Help Viewer**
* Microsoft Internet Explorer® 5.0 or later must be installed.
The On-screen Manual may not be displayed properly depending on your operating system or Internet Explorer version. We recommend that you keep your system up to date with Windows Update.

Macintosh

- **Browser: Help Viewer**
* The On-screen Manual may not be displayed properly depending on your operating system. We recommend that you keep your system up to date.

Users in the U.S.A.

Pre-Installation Requirements for MP530

A. Location

Supply a suitable table, cabinet, or desk for the machine. See the Appendix for the machine's specific dimensions and weight.

B. Order Information

1. Only a single telephone line (touch-tone or rotary) should be used.
2. Order an RJ11-C modular wall jack (USOC code), which should be installed by the telephone company. If the RJ11-C modular wall jack is not present, telephone/fax operation is not possible.
3. Order a normal business line from your telephone company's business representative. The line should be a regular voice grade line or the equivalent one. Use one line per machine.
DDD (Direct Distance Dial) line
-or-
IDDD (International Direct Distance Dial) line if you communicate overseas

Note

Canon recommends an individual line following industry standards, such as the 2500 (touch-tone) or 500 (rotary/pulse dial) telephones. A dedicated extension off a PBX (Private Branch Exchange) unit without "Call Waiting" can be used with the machine. Button telephone systems are not recommended because they send nonstandard signals to individual telephones for ringing and special codes, which may cause a fax error.

C. Power Requirements

This machine should be connected to a standard 120 volt AC, two-prong grounded outlet only. Do not connect this machine to an outlet or power line shared with other appliances that cause "electrical noise." Air conditioners, electric typewriters, copiers, and machines of this sort generate electrical noise which often interferes with communications equipment and the sending or receiving of documents.

Connection of the Equipment

This equipment complies with Part 68 of the FCC rules and the requirements adopted by the ACTA. On the rear panel of this equipment is a label that contains, among other information, a product identifier in the format US:AAAEQ##TXXXX. If requested, this number must be provided to the telephone company.

The REN is used to determine the number of devices that may be connected to a telephone line. Excessive RENs on a telephone line may result in the devices not ringing in response to an incoming call. In most but not all areas, the sum of RENs should not exceed five (5.0). To be certain of the number of devices that may be connected to a line, as determined by the total RENs, contact the local telephone company. The REN for this product is part of the product identifier that has the format US:AAAEQ##TXXXX. The digits represented by ## are the REN without a decimal point (e.g., 03 is a REN of 0.3).

An FCC compliant telephone line cable cord and modular plug is provided with this equipment. This equipment is designed to be connected to the telephone network or premises wiring using a compatible modular jack which is Part 68 compliant. See Installation instructions for details.

This equipment if it uses a telephone receiver is hearing aid compatible.

This equipment may not be used on coin service provided by the telephone company. Connection to party lines is subjected to state tariffs.

In Case of Equipment Malfunction

Should any malfunction occur which cannot be corrected by the procedures described in this guide, disconnect the equipment from the telephone line cable, turn off the power and disconnect the power cord. The telephone line cable should not be reconnected or the main power switch turned ON until the problem is completely resolved. Users should contact their local authorized Canon Facsimile Service Dealer for the servicing of equipment.

Rights of the Telephone Company

If this equipment causes harm to the telephone network, the telephone company may temporarily disconnect service. The telephone company also retains the right to make changes in facilities and services that may affect the operation of this equipment. When such changes are necessary, the telephone company is required to give adequate prior notice to the user. However, if advance notice is not possible, the telephone company will notify the customer as soon as possible. Also, the customer will be advised of his/her right to file a complaint with the FCC if he/she believes it is necessary.

Warning

The Telephone Consumer Protection Act of 1991 makes it unlawful for any person to use a computer or other electronic device to send any message via a telephone facsimile machine unless such message clearly contains in a margin at the top or bottom of each transmitted page, or on the first page of the transmission, the date and time it is sent and an identification of the business or other entity, or other individual sending the message and the telephone number of the sending machine or such business, other entity, or individual.

In order to program this information into your machine, you should complete the procedure to register your name, unit's telephone number, time, and date.

FCC Notice

Model Number: K10269

This device complies with Part 15 of the FCC Rules. Operation is subject to the following two conditions:

- (1) This device may not cause harmful interference, and
- (2) this device must accept any interference received, including interference that may cause undesired operation.

Note

This equipment has been tested and found to comply with the limits for a class B digital device, pursuant to Part 15 of the FCC Rules. These limits are designed to provide reasonable protection against harmful interference in a residential installation. This equipment generates, uses and can radiate radio frequency energy and, if not installed and used in accordance with the instructions, may cause harmful interference to radio communications. However, there is no guarantee that interference will not occur in a particular installation. If this equipment does cause harmful interference to radio or television reception, which can be determined by turning the equipment off and on, the user is encouraged to try to correct the interference by one or more of the following measures:

- Reorient or relocate the receiving antenna.
- Increase the separation between the equipment and receiver.
- Connect the equipment into an outlet on a circuit different from that to which the receiver is connected.
- Consult the dealer or an experienced radio/TV technician for help.

Use of shielded cable is required to comply with class B limits in Subpart B of Part 15 of the FCC Rules.

Warning

Do not make any changes or modifications to the equipment unless otherwise specified in this guide. If such changes or modifications should be made, you could be required to stop operation of the equipment.

Canon U.S.A., INC. LIMITED WARRANTY --- (USA Only)

The limited warranty set forth below is given by Canon U.S.A., Inc. ("Canon USA") with respect to the new or refurbished Canon brand product ("Product") packaged with this limited warranty, when purchased and used in the United States only.

The Product is warranted against defects in materials and workmanship under normal use and service (a) for a period of one (1) year from the date of original purchase when delivered to you in new condition in its original container or (b) for 90 days from the date of original purchase for refurbished Products. Defective parts or a defective Product returned to a Canon USA repair facility or a Canon USA Authorized Service Facility ("ASF"), and proven to be defective upon inspection will be (a) repaired; (b) exchanged for new or comparable rebuilt, recovered, remanufactured, repaired and/or recycled parts or; (c) exchanged for a refurbished Product, as determined by the Canon USA repair facility or the ASF. Warranty repair or replacement shall not extend the original warranty period of the Product. A dated proof of purchase is required at the time of warranty service. A copy of your dated bill of sale will satisfy this requirement. This warranty does not cover any accessories, or any consumables, such as paper or ink cartridges, as to which there shall be no warranty or replacement.

This limited warranty shall only apply if the Product is used in conjunction with compatible computers, peripheral equipment and software. Canon USA shall have no responsibility for such items except for compatible Canon brand peripheral equipment covered by a separate warranty ("Separate Warranty"). Repairs of such Canon brand peripheral equipment shall be governed by the terms of the Separate Warranty. Non-Canon brand equipment and software that may be distributed with the Product are sold "as is" and without warranty of any kind by Canon USA, including any implied warranty regarding merchantability or fitness for a particular purpose, and all such warranties are disclaimed. The sole warranty, if any, with respect to such non-Canon brand items is given by the manufacturer or producer thereof.

This limited warranty covers all defects encountered in normal use of the Product and does not apply in the following cases:

- (a) Loss of or damage to the Product due to abuse, neglect, mishandling, improper packaging by you, alteration, accident, electrical current fluctuations, improper use, failure to follow operating or maintenance instructions in, or environmental conditions prescribed in, Canon USA's user's manual or other documentation, or services performed by someone other than a Canon USA repair facility or ASF. Without limiting the foregoing, dropping the Product, scratches, and abrasions will be presumed to have resulted from misuse, abuse or failure to operate the Product as set forth in the user's manual or other documentation for the Product.
- (b) Use of parts, media, software or supplies (other than those sold by Canon USA), including non-Canon ink cartridges or refilled ink cartridges, that cause damage to the Product or cause abnormally frequent service calls or service problems.
- (c) If the Product has had its serial number or dating defaced, altered or removed.

ANY SYSTEM SOFTWARE (WHETHER FACTORY LOADED ON THE PRODUCT OR CONTAINED ON THE SOFTWARE DISKETTES OR CDROMS ENCLOSED WITH, OR ACCOMPANYING, THE PRODUCT), AND ANY UTILITY SOFTWARE, DISTRIBUTED WITH OR FOR THE PRODUCT, IS SOLD "AS IS" AND WITHOUT WARRANTY BY CANON USA. THE SOLE WARRANTY WITH RESPECT TO SUCH SOFTWARE IS CONTAINED IN THE SOFTWARE MANUFACTURER'S LICENSE AGREEMENT DISTRIBUTED THEREWITH, INCLUDING ANY LIMITATIONS AND DISCLAIMERS THEREON. PLEASE CONTACT CANON USA IMMEDIATELY IF YOU HAVE NOT RECEIVED A COPY OF THE SOFTWARE MANUFACTURER'S LICENSE AGREEMENT.

NO IMPLIED WARRANTY, INCLUDING ANY IMPLIED WARRANTY OF MERCHANTABILITY OR FITNESS FOR A PARTICULAR PURPOSE, APPLIES TO THE PRODUCT AFTER THE APPLICABLE PERIOD OF THE EXPRESS LIMITED WARRANTY STATED ABOVE, AND NO OTHER EXPRESS WARRANTY OR GUARANTY, EXCEPT AS MENTIONED ABOVE, GIVEN BY ANY PERSON OR ENTITY WITH RESPECT TO THE PRODUCT SHALL BIND CANON USA, OR ITS ASF. (SOME STATES DO NOT ALLOW LIMITATIONS ON HOW LONG AN IMPLIED WARRANTY LASTS, SO THE ABOVE LIMITATION MAY NOT APPLY TO YOU.) CANON USA SHALL NOT BE LIABLE FOR LOSS OF REVENUES OR PROFITS, INCONVENIENCE, EXPENSE FOR SUBSTITUTE EQUIPMENT OR SERVICE, STORAGE CHARGES, LOSS OR CORRUPTION OF DATA, OR ANY OTHER SPECIAL, INCIDENTAL OR CONSEQUENTIAL DAMAGES CAUSED BY THE USE, MISUSE, OR INABILITY TO USE THE PRODUCT REGARDLESS OF THE LEGAL THEORY ON WHICH THE CLAIM IS BASED, AND EVEN IF CANON USA OR ITS ASF HAS BEEN ADVISED OF THE POSSIBILITY OF SUCH DAMAGES. NOR SHALL RECOVERY OF ANY KIND AGAINST CANON USA OR ITS ASF BE GREATER IN AMOUNT THAN THE PURCHASE PRICE OF THE PRODUCT CAUSING THE ALLEGED DAMAGE. WITHOUT LIMITING THE FOREGOING, YOU ASSUME ALL RISK AND LIABILITY FOR LOSS, DAMAGE OR INJURY TO YOU AND YOUR PROPERTY AND TO OTHERS AND THEIR PROPERTY ARISING OUT OF THE POSSESSION, USE, MISUSE, OR INABILITY TO USE THE PRODUCT SOLD BY CANON USA NOT CAUSED SOLELY AND DIRECTLY BY THE NEGLIGENCE OF CANON USA, OR ITS ASF. (SOME STATES DO NOT ALLOW THE EXCLUSION OR LIMITATION OF INCIDENTAL OR CONSEQUENTIAL DAMAGES, SO THE ABOVE EXCLUSION OR LIMITATION MAY NOT APPLY TO YOU.) THIS LIMITED WARRANTY SHALL NOT EXTEND TO ANYONE OTHER THAN THE ORIGINAL PURCHASER OF THE PRODUCT OR THE PERSON FOR WHOM IT WAS PURCHASED AS A GIFT, AND STATES YOUR EXCLUSIVE REMEDY.

Canon USA offers a range of customer technical support* options:

- Interactive troubleshooting, e-mail technical support, the latest driver downloads and answers to frequently asked questions (www.canontechsupport.com)
- Toll-free live technical support Monday—Saturday (excluding holidays) at **1-800-828-4040**
- Telephone Device for the Deaf (**TDD-1-866-251-3752**)
- Repair or Exchange Service Options:

In the event service is required for the Product during the limited warranty period, Canon USA offers two hardware support options:

Authorized Service Facility Carry-In / Mail-In Service

Canon USA's Carry-In/Mail-In Service provides repair or exchange, at Canon USA's option, through Canon USA's Authorized Service Facility (ASF) network. The name and telephone number of the ASF(s) near you may be obtained from Canon USA's Web site at www.canontechsupport.com or by calling the Canon USA Customer Care Center at 1-800-828-4040, or any time while speaking to a technical support person. A Product covered by this limited warranty will be repaired or exchanged, as determined by Canon USA, and returned without charge by the ASF.

InstantExchange Service **

A Canon Customer Care Center or ASF technician will attempt to diagnose the nature of the problem and, if possible, correct it over the telephone. If the problem cannot be corrected over the telephone, and you elect the InstantExchange option, a reference number will be issued to you. You will be asked for the Product serial number and other information pertaining to your defective Product and for a ship-to location for the replacement Product (must include street address).

The Canon USA repair facility will ship out the replacement Product, via 2nd day Air freight service, prepaid by Canon USA. After receipt of the replacement Product (with instructions and a prepaid waybill), follow the enclosed instructions on how to ship the defective Product to the Canon USA repair facility. The defective Product must be returned in the shipping carton in which the replacement Product was packed and include the reference number, A COPY OF YOUR DATED PROOF OF PURCHASE (BILL OF SALE), and a complete explanation of the problem. DO NOT INCLUDE ANY OTHER ITEMS WITH THE DEFECTIVE PRODUCT IN THE RETURN SHIPPING

CARTON, AND BE SURE TO RETAIN YOUR PRINTHEAD AND INK CARTRIDGE(S) AND TANK(S). InstantExchange Service expedites, usually by the second business day, the exchange of a defective Product with a replacement Product, which will normally be shipped the same day if your request for this service is by 3 p.m. E.T. Monday through Friday, except holidays (three (3) business day InstantExchange Service for Alaska and Hawaii). Canon USA does not guarantee expedited shipping service in the event of the occurrence of factors beyond its reasonable control. The replacement Product you receive may be a refurbished or reconditioned unit and will be covered for the balance of the period remaining on your original limited warranty. NOTE THAT BY USING THIS SERVICE YOU WILL KEEP THE REPLACEMENT PRODUCT THAT IS SENT TO YOU. CANON USA WILL RETAIN THE DEFECTIVE PRODUCT THAT YOU ORIGINALLY PURCHASED, WHICH SHALL BECOME THE PROPERTY OF CANON USA. InstantExchange warranty program service is available only during the express limited-warranty period for your Product and only in the continental United States, Alaska and Hawaii during such period.

This limited warranty gives you specific legal rights, and you may also have other rights, which vary from state to state.

* Support program specifics are subject to change without notice.

** InstantExchange warranty service is subject to the availability of refurbished or new replacement units.

Canon U.S.A., Inc.
One Canon Plaza
Lake Success, NY 11042
USA

©2006 Canon U.S.A., Inc. Canon is a registered trademark of Canon Inc. in the United States and may also be a registered trademark in other countries.

Users in Canada

Pre-Installation Requirements for Canon Facsimile Equipment

A. Location

Supply a suitable table, cabinet, or desk for the machine. See the Appendix for the machine's specific dimensions and weight.

B. Order Information

1. Provide only a single line touch-tone or rotary telephone set terminated with a standard 6-pin modular telephone plug. (Touch-tone is recommended if available in your area.)
2. Order a CA11A modular wall jack, which should be installed by the telephone company. If the CA11A modular wall jack is not present, installation cannot occur.
3. Order a normal business line from your telephone company's business representative. The line should be a regular voice grade line or an equivalent one. Use one line per machine.
DDD (Direct Distance Dial) line
-or-
IDDD (International Direct Distance Dial) line if you communicate overseas



Note

Canon recommends an individual line following industry standards, such as the 2500 (touch-tone) or 500 (rotary / pulse dial) telephones. A dedicated extension off a PBX (Private Branch Exchange) unit without "Call Waiting" can be used with your facsimile unit. Button telephone systems are not recommended because they send non-standard signals to individual telephones for ringing and special codes, which may cause a fax error.

C. Power Requirements

The power outlet should be a two-prong grounded receptacle (Single or Duplex). It should be independent from copiers, heaters, air conditioners or any electric equipment that is thermostatically controlled. The rated value is 120 volts and 15 amperes. The CA11A modular jack should be relatively close to the power outlet to facilitate installation.

Notice

This equipment meets the applicable Industry Canada terminal Specifications.

Avis

Le présent matériel est conforme aux spécifications techniques applicables d'Industrie Canada.

Before installing this equipment, users should ensure that it is permitted to be connected to the facilities of the local telecommunications company. The equipment must also be installed using an acceptable method of connection. In some cases, the company's inside wiring associated with a single-line individual service may be extended by means of a certified connector assembly (telephone extension cord). The customer should be aware that compliance with the above conditions may not prevent degradation of service in some situations.

The Ringer Equivalence Number is an indication of the maximum number of devices allowed to be connected to a telephone interface. The termination on an interface may consist of any combination of devices subject only to the requirement that the sum of the RENs of all the devices does not exceed five.

Even if the dual-line option is installed, the REN is applicable to each port.

Avis

L'indice d'équivalence de la sonnerie (IES) sert à indiquer le nombre maximal de terminaux qui peuvent être raccordés à une interface téléphonique. La terminaison d'une interface peut consister en une combinaison quelconque de dispositifs, à la seule condition que la somme d'indices d'équivalence de la sonnerie de tous les dispositifs n'excède pas 5.

Repairs to certified equipment should be made by an authorized Canadian maintenance facility designated by the supplier. Any repairs or alterations made by the user to this equipment, or equipment malfunctions, may give the telecommunications company cause to request the user to disconnect the equipment.

Users should ensure for their own protection that the electrical ground connections of the power utility, telephone lines and internal metallic water pipe system, if present, are connected together. This precaution may be particularly important in rural areas.

Caution

- Users should not attempt to make such connections themselves, but should contact the appropriate electric inspection authority, or electrician, as appropriate.
- This Class B digital apparatus meets all requirements of the Canadian Interference-Causing Equipment Regulations.
- Cet appareil numérique de la classe B respecte toutes les exigences du Règlement sur le matériel brouilleur du Canada.

Customer Technical Supports

Canon Canada Inc., offers a full range of customer technical support* options:

- For interactive troubleshooting, e-mail technical support, the latest driver downloads and answers to frequently asked questions (www.canon.ca)
- Free live technical support Mon - Fri 9am-8pm EST (excluding holidays) for products still under warranty (1-800-OK-CANON)
- The location of the authorized service facility nearest you (1-800-OK-CANON)

If the problem cannot be corrected by using one of the above technical support options, repair options are available at the time of your call to the Free live technical support number above or via the website at www.canon.ca

* Support program specifics are subject to change without notice.

CANON CANADA INC.

1-800-OK-CANON (1-800-652-2666)

<http://www.canon.ca>

Users in New Zealand

The grant of a Telepermit for any item of terminal equipment indicates only that Telecom has accepted that the item complies with the minimum conditions for connection to its network. It indicates no endorsement of the product by Telecom, nor does it provide any sort of warranty. Above all, it provides no assurance that any item will work correctly in all respects with another item of Telepermitted equipment of a different make or model, nor does it imply that any product is compatible with all of Telecom's network services.

Telepermitted equipment only may be connected to the auxiliary telephone port. The auxiliary telephone port is not specifically designed for 3-wire-connected equipment. 3-wire-connected equipment might not respond to incoming ringing when attached to this port.

The automatic calling functions of this equipment must not be used to cause a nuisance to other Telecom customers.

This equipment may not provide for the effective hand-over of a call to or from a telephone connected to the same line.

This device may be subject to ringing or bell tinkle when certain other devices are connected to the same line. If this occurs, the problem should not be referred to the Telecom Faults Service.

Index

Symbols

(-) and (+) button 17

A

ACTIVITY REPORT 70

printing 71

ADF (Auto Document Feeder) 12

Alarm Lamp 16

Appendix 151

Auto Sheet Feeder 12

Auto Sheet Feeder Lamp 17

B

Back button 17

Before Printing 12

Black button 17

C

Cassette 13

Cassette Lamp 17

Changing the Machine Settings 91

audible tones 96

country select 96

fax settings 92

language setting 96

load config 97

print settings 91

pwr save setting 96

restore default 96

save config 97

Changing the Page Size and Media Type 37

Recommended Paper and Requirements 37

Cleaning 109

ADF (Automatic Document Feeder) 108

bottom plate 109

platen glass and document cover 107

roller 108

CLI-8BK Black 98

CLI-8C Cyan 98

CLI-8M Magenta 98

CLI-8Y Yellow 98

Coded Dial button 16

Color button 17

Components 12

COPY button 16

Copying 40

2-on-1 copy 45

4-on-1 copy 46, 47

auto adjust 42

borderless copy 48

collated copy 51

fit-to-page 42

image repeat 49

intensity 40

preset ratio 41

reducing or enlarging 41

sticker copy 47

two-sided copy 43

zoom 41

Cover Guide 12

D

Date

entering 63

Direct Print Port 13

Document Cover 12

Document Guides 12

Document Output Slot 12

Document Tray 12

Duplexing Transport Unit 15

E

Enlarge/Reduce button 16

Entering Numbers, Letters, and Symbols 68

Exposure button 16

External Device Jack 15

F

Fax

canceling receiving 83

memory receiving 83

receiving 78

sending 71

sending from your computer 75

sending from your machine 73

FAX button 16

Fax Settings

date and time 63

sender information 64

summer time 67

telephone line type 62

Fax/telephone number

registering 64

Faxing 60

Feed Switch button 17

Feeder Cover 12

I

Image quality

adjusting for faxing 72

Image Quality button 17

In Use/Memory Lamp 16

Ink Lamp 14

Inner Cover 14

L

LCD (Liquid Crystal Display) 16

Letters

entering 68

Loading Documents 19

Loading Paper
 auto sheet feeder 27
 cassette 31
 recommended paper and requirements 22

M

Maintenance
 cleaning your machine 107
Memory
 checking a document's details in 77
 deleting a document in 77
 printing the memory list 76
Menu button 16

N

Nozzle Check Pattern
 examining 105
 printing 104
Numeric Buttons 16

O

OK button 17
ON/OFF button 16
Open button 13
Operation Panel 13, 16

P

Paper button 17
Paper Guide 12
Paper Output Tray 13
Paper Support 12
PGI-5BK Black 98
Platen Glass 13
Power Cord Connection 15
Power save setting 96
Print Head
 adjusting the print head manually 117
 aligning print head automatically 106
 cleaning 105
 deep cleaning 106
Print Head Holder 14
Print Head Lock Lever 14
Printing Area 151
Printing from Your Computer 84
 Macintosh 86
 Windows 84
Printing Photographs Directly from a Compliant
 Device 53
 Canon Bubble Jet Direct 58
 Connecting 53
 PictBridge 55

R

Rear Cover 15
Receiving Faxes 78
 canceling receiving 83
 memory receiving 83
 paper size and type 79

 receive modes 80
Redial/Pause button 16
Redialing 76
Registering
 sender information 62
Registering Speed Dials
 coded speed dialing 65
Replacing Ink Tanks 99
Reports and Lists 70
Routine Maintenance 98
 Replacing Ink Tanks 99
RX (Reception) REPORT 70
 printing 71

S

Safety Precautions 5
SCAN button 16
Scan contrast
 adjusting 73
Scanning Images 89
Scanning Unit (Printer Cover) 14
Sender information
 registering 62
Sending Faxes 71
 automatic redialing 76
 dialing through a switchboard 78
 fax resolution 72
 manual redialing 76
 manual sending 74
 memory sending 73
 scan contrast 73
Sending methods 73
Special dialing 78
 sending/receiving using ECM 78
 switchboard 78
Specifications
 Canon Bubble Jet Direct 158
 copy 156
 fax 156
 general 155
 PictBridge 157
 scan 158
 telephone 157
Stop/Reset button 17
Symbols
 entering 68
System Requirements 158

T

Telephone
 line type setting 62
Telephone Line Jack 15
Time
 entering 63
Tone button 17
Troubleshooting 111
 paper jams 127, 130
Turning the Machine ON and OFF 18
Two-Sided button 17

TX (Transmission) REPORT 70
printing 71

U

USB Port 15
USER'S DATA LIST 70
printing 71

This product uses the following copyrighted software:

exit.c Copyright © 1990 The Regents of the University of California.
All rights reserved.

Redistribution and use in source and binary forms are permitted provided that the above copyright notice and this paragraph are duplicated in all such forms and that any documentation, advertising materials, and other materials related to such distribution and use acknowledge that the software was developed by the University of California, Berkeley. The name of the University may not be used to endorse or promote products derived from this software without specific prior written permission.

THIS SOFTWARE IS PROVIDED "AS IS" AND WITHOUT ANY EXPRESS OR IMPLIED WARRANTIES, INCLUDING, WITHOUT LIMITATION, THE IMPLIED WARRANTIES OF MERCHANTABILITY AND FITNESS FOR A PARTICULAR PURPOSE.

environ.c Copyright © 1995, 1996 Cygnus Support.
All rights reserved.

Redistribution and use in source and binary forms are permitted provided that the above copyright notice and this paragraph are duplicated in all such forms and that any documentation, advertising materials, and other materials related to such distribution and use acknowledge that the software was developed at Cygnus Support, Inc. Cygnus Support, Inc. may not be used to endorse or promote products derived from this software without specific prior written permission.

THIS SOFTWARE IS PROVIDED "AS IS" AND WITHOUT ANY EXPRESS OR IMPLIED WARRANTIES, INCLUDING, WITHOUT LIMITATION, THE IMPLIED WARRANTIES OF MERCHANTABILITY AND FITNESS FOR A PARTICULAR PURPOSE.

impure.c Copyright © 1994, 1997 Cygnus Solutions.
string.h All rights reserved.
_ansi.h

Redistribution and use in source and binary forms are permitted provided that the above copyright notice and this paragraph are duplicated in all such forms and that any documentation, advertising materials, and other materials related to such distribution and use acknowledge that the software was developed at Cygnus Solutions. Cygnus Solutions may not be used to endorse or promote products derived from this software without specific prior written permission.

THIS SOFTWARE IS PROVIDED "AS IS" AND WITHOUT ANY EXPRESS OR IMPLIED WARRANTIES, INCLUDING, WITHOUT LIMITATION, THE IMPLIED WARRANTIES OF MERCHANTABILITY AND FITNESS FOR A PARTICULAR PURPOSE.

Ordering Information

For additional supplies, use the following descriptions and order numbers.

Description	Order #
--------------------	----------------

Ink Tanks

CLI-8 BK	0620B002
CLI-8 C	0621B002
CLI-8 M	0622B002
CLI-8 Y	0623B002
PGI-5 BK	0628B002

Canon Specialty Papers

Photo Paper Plus Glossy (4" x 6"/20 sheets)	7980A007
Photo Paper Plus Glossy (4" x 6"/50 sheets)	7980A012
Photo Paper Plus Glossy (4" x 6"/120 sheets)	7980A022
Photo Paper Plus Glossy (5" x 7"/20 sheets)	7980A019
Photo Paper Plus Glossy (8.5" x 11"/20 sheets)	7980A006
Photo Paper Plus Double Sided (5" x 7"/10 sheets)	9981A006
Photo Paper Plus Double Sided (8.5" x 11"/10 sheets)	9981A005
Photo Paper Plus Double Sided Album Kit (5" x 7")	0041B005
Photo Paper Plus Double Sided Album Kit (8.5" x 11")	0041B006
Photo Paper Pro for Borderless Printing (4" x 6"/20 sheets)	1029A014
Photo Paper Pro for Borderless Printing (4" x 6"/75 sheets)	1029A027
Photo Paper Pro (8.5" x 11"/15 sheets)	1029A004
Photo Paper Pro (8.5" x 11"/30 sheets)	1029A028
Photo Paper Pro (8" x 10"/20 sheets)	1029A059
Matte Photo Paper (4" x 6"/120 sheets)	7981A014
Matte Photo Paper (8.5" x 11"/50 sheets)	7981A004
Photo Paper Glossy (4" x 6"/50 sheets)	0755B021
Photo Paper Glossy (4" x 6"/100 sheets)	0775B022
Photo Paper Glossy (8.5" x 11"/50 sheets)	0775B023
Photo Paper Glossy (8.5" x 11"/100 sheets)	0775B024
Glossy Photo Paper Credit Card Size	9157A023
Photo Stickers	0001C001
High Resolution Paper (8.5" x 11"/100 sheets)	1043A011

Call 1-800-OK-CANON to locate a dealer near you, or visit the Canon eStore at www.estimate.usa.canon.com.





Canon U.S.A., Inc.

One Canon Plaza, Lake Success, NY 11042, U.S.A.

Canon Inc.

30-2, Shimomaruko 3-chome, Ohta-ku, Tokyo 146-8501, Japan

Canon Canada, Inc.

6390 Dixie Road, Mississauga, Ontario, L5T 1P7, Canada

Canon Latin America, Inc.

703 Waterford Way, Suite 400, Miami, FL 33126, U.S.A.

Canon Mexicana

Boulevard Manuel Avila Camacho No. 138 PB
y Pisos 15, 16 y 17, Colonia Lomas de Chapultepec
Delegación Miguel Hidalgo, CP 11000, Mexico D.F.

The following ink tanks are compatible with this machine.
For details on ink tank replacement, refer to "Replacing Ink Tanks" in this guide.



CLI-8BK



PGI-5BK



CLI-8Y



CLI-8M



CLI-8C